



REGENT EDUCATION & RESEARCH FOUNDATION

Group of Institutions

1.3.1: Institution integrates crosscutting issues relevant to Professional Ethics, Gender, Human Values, Environment and Sustainability in transacting the Curriculum

SL No	Name of the course	Course Code	Course Out come	Addressing concerns
1	Indian Constitution	MC-EE 301	After completion of this course, the learners will be able to 1. illustrate different aspects of human values, ethics, engineers' responsibility and duties 2. explain different principles, different theories and laws of engineering ethics and social experimentation 3. identify different factors in the light of Engineers' responsibility towards safety and risk 4. correlate ethics of different work environment. 5. explain the need for intellectual property right	Professional Ethics, Gender & Human Values
2	Values and Ethics in profession	HM-EE401	After completion of this course, the learners will be able to describe different features of Indian constitution/power and functioning of Union, state and local self-government/structure, jurisdiction and function of Indian Judiciary/ basics of PIL and guideline for admission of PIL./ Functioning of local administration starting from block to Municipal Corporation.	Professional Ethics, Gender & Human Values
3	Environmental Science	MC 481,	CO1-Be able to understand the natural environment and its relationships with human activities. CO2-Be able to apply the fundamental knowledge of science and engineering to assess environmental and health risk CO3-Be able to understand environmental laws and regulations to develop guidelines and procedures for health and safety issues CO4-Be able to solve scientific problem-solving to air, water, noise and land pollution. CO5-Students will learn how to effectively carry out a work done either in single or as a team member	Environment and Sustainability
4	Values and Ethics in profession	HM-EEE-401	After completion of this course, the learners will be able to describe different features of Indian constitution/power and functioning of Union, state and local self-government/structure, jurisdiction and function of Indian Judiciary/ basics of PIL and guideline for admission of PIL./ Functioning of local administration starting from block to Municipal Corporation.	Professional Ethics & Human Values
5	Values and Ethics in Profession	HU301	learn about the ethical responsibilities of the engineers. create awareness about the customs and religions. learn time management learn about the different professional roles.	Professional Ethics & Human Values

Principal



**REGENT
EDUCATION &
RESEARCH FOUNDATION**
Group of Institutions

6	Environmental Engineering and Elementary Biology	CH(FT) 301,	<p>Identify, formulate and solve complex engineering problems by applying principals of engineering, science and mathematics.</p> <p>Apply engineering design to produce solutions that meet specified needs with consideration of public health, safety and welfare, as well as global, cultural, social, environmental and economic factors.</p> <p>Communicate effectively with a range of audiences.</p> <p>Recognize ethical and professional responsibilities in engineering situations and make informed judgments, which must consider the impact of engineering solutions in global, economic, environmental and societal contexts.</p> <p>Function effectively on a team whose members together provide leadership, create a collaborative and inclusive environment, establish goals, plan tasks and meet objectives.</p>	Environment and Sustainability
7	Environmental Sciences	MC401	<p>Students will understand key concepts in the life and physical sciences and will apply them to environmental issues.</p> <p>Students will understand and apply the scientific process, as well as appreciate both the potential and limitations of the process.</p> <p>Students will be able to locate, evaluate and synthesize information from the scientific literature.</p> <p>Students will analyze data using appropriate statistical methods and will be able to evaluate the use of statistics by others in a variety of contexts</p>	Environment and Sustainability
8	Environmental Science	MC381	<p>CO1-Be able to understand the natural environment and its relationships with human activities.</p> <p>CO2-Be able to apply the fundamental knowledge of science and engineering to assess environmental and health risk</p> <p>CO3-Be able to understand environmental laws and regulations to develop guidelines and procedures for health and safety issues</p> <p>CO4-Be able to solve scientific problem-solving to air, water, noise and land pollution.</p> <p>CO5-Students will learn how to effectively carry out a work done either in single or as a team member</p>	Environment and Sustainability
9	Indian Ethics & Business Ethics	MB-105	<p>Enhance awareness and critical self-examination of one's own values, and to appreciate the relevance of personal values in the business/workplace setting; and. Encourage reflection on the ethical dimension of your own decision-making in workplace and other settings.</p>	Professional Ethics

Principal

Regent Education & Research Foundation
Bara Kanthalia, P.O-Sewli Telinipara
Barrackpore, Kolkata- 700121



**REGENT
EDUCATION &
RESEARCH FOUNDATION**
Group of Institutions

10	Environment and Ecology	MCAN-E105A	Be able to understand the natural environment and its relationships with human activities. Be able to apply the fundamental knowledge of science and engineering to assess environmental and health risk. Be able to understand environmental laws and regulations to develop guidelines and procedures for health and safety issues. Be able to solve scientific problem-solving to air, water, noise and land pollutions.	Environment and Sustainability
----	-------------------------	------------	---	--------------------------------

Principal
Regent Education & Research Foundation
Bara Kanthalia, P.O -Sewli Telinipara
Barrackpore, Kolkata- 700121

PRINCIPAL



REGENT EDUCATION & RESEARCH FOUNDATION
GROUP OF INSTITUTIONS

PROJECT REPORT
ON
RAINWATER HARVESTING
REGENT EDUCATION AND RESEARCH FOUNDATION
GROUP OF INSTITUTIONS



Prepared by: CIVIL ENGINEERING DEPARTMENT

Dr. Kaushik Dutta Roy
Associate Professor
Principal Investigator
Department of Civil Engineering

Mr. Yuvaraj Mondal
Assistant Professor
Co- Principal Investigator
Department of Civil Engineering

Dr. Rajorshi Bandyopadhyay
DR. RAJORSHI BANDYOPADHYAY, (Principal)
REGENT EDUCATION & RESEARCH FOUNDATION
Bara Kathalia, Sweli Telinipara
Barrckpore, Kolkata - 700121.

Ms. Payel Chakraborty
Senior Technical Assistant
Co-Principal Investigator
Department of Civil Engineering

Mr. Chinmay Majumder
Senior Technical Assistant
Co- Principal Investigator
Department of Civil Engineering

Mr. Shouvik Sarkar
Assistant Professor
HOD
Department of Civil Engineering



Campus: Regent Education & Research Foundation Group of Institutions

E-mail: rerfkolkata@gmail.com, Website: www.rerf.in

Campus Address:

BaraKanthalia, Barrackpore
P.O: Sewli Telinipara,
P.S.: Titagarh, Kolkata - 700121
Tel.: 033-3008-5442/432/431, Fax: 033-3008-5442

Regd. Office Address:

11/3, Biresh Guha Street
7th Floor, Kolkata-700017



**REGENT EDUCATION & RESEARCH FOUNDATION
GROUP OF INSTITUTIONS**

Name of Students Involved in the project

Name	Roll No
Soumi Das	26301321081
Naurin Sultana	26301321094
UJJAL BISWAS	26301321121
Brayen Sarkar	26301321033
NARAYAN KHANRA	26301322025
Abhijeet Banerjee	26301320012
Indrani Dutta	26301321091
Sujan Kumar Dey	26301321090

DR. RAJORSHI BANDYOPADHYAY, (Principal)
REGENT EDUCATION & RESEARCH FOUNDATION
Bara Kathalia, Sweli Telinipara
Barrckpore, Kolkata - 700121.

Campus: Regent Education & Research Foundation Group of Institutions

E-mail: rerfkolkata@gmail.com, Website: www.rerf.in

Campus Address:

BaraKanthalia, Barrackpore
P.O: Sewli Telinipara,
P.S.: Titagarh, Kolkata - 700121
Tel.:033-3008-5442/432/431, Fax:033-3008-5442

Regd Office Address:

11/3, Biresh Guha Street
7th Floor, Kolkata-700017



REGENT EDUCATION & RESEARCH FOUNDATION GROUP OF INSTITUTIONS

Rain Water Harvesting Project in Regent Education and Research Foundation Group of Institutions

Introduction:

Rainwater harvesting is an important environment friendly approach – dubbed as a Green Practice which has double benefit in both keeping the groundwater table undisturbed and charging the aquifer. Such a green practice encouraged in form of Community Development Program can find its popularity when it shows the manifold benefits of, in one hand, bringing people together to collective thinking on 'green' approaches, innovating approaches to save earth by harping on their creative notes, achieving nobler feelings saving water for future; on the other hand, rainwater as well as run-off storm water stored in a planned way save the earth from soil erosion, flood; recharge the aquifers to give a shot in the arm to the decreasing groundwater table.

The increasing urbanization lead to concentrated population density at places resulting into uneven drawing of ground water. This is ensuing into draught and drying up of river beds at places where domestic and industrial use of water is rising. This places if shift focus towards using rainwater, the groundwater there may gradually fall back to its normal level thus ensuring the eco-balance not lost. The extensive and unplanned usage of groundwater not only disturbed the natural water table but also has made the groundwater contaminated and, in many a place, totally unfit for any use. The groundwater in these places required to be immediately left to revive. Collecting rainwater, and harvesting the storm water run-offs, in these places, surely would minimize the risk of the future population here.

Rainwater harvesting, besides being eco-friendly, is an economic practice as well. The cost of digging a catchment area even can be saved by a roof-top collection of rainwater. The freshwater canals or rain-fed natural ponds too can be used for harvesting. Sand-gravel filters for purifying rainwater is again something that can be easily arranged. The catchments and settlement tanks built in the area easily free the spot and the vicinity from the curse of flood or water logging, thus saving money of pumping outdirty muddy storm water. The presence of a water body in the region also reduces the ground heat and acts as a natural cooler.

The best part of the practice of rainwater harvesting, however, is that in one hand it is checking one from leaning towards using groundwater as rainwater is obtained in abundance in many countries; on the other hand, if remains unused or extra, this rainwater, collected in say natural ponds or even in artificial tanks can pour back to the ground thus charging the natural aquifer to boost the groundwater level.

DR. RAJORSHI BANDYOPADHYAY, (Principal)
REGENT EDUCATION & RESEARCH FOUNDATION
Bara Kathalia, Sweli Telinipara
Barrckpore, Kolkata - 700121

Campus: Regent Education & Research Foundation Group of Institutions

E-mail: rerfkolkata@gmail.com, Website: www.rerf.in

Campus Address:

BaraKanthalia, Barrackpore
P.O: Sewli Telinipara,
P.S.: Titagarh, Kolkata - 700121
Tel.: 033-3008-5442/432/431, Fax: 033-3008-5442

Regd. Office Address:

11/3, Biresh Guha Street
7th Floor, Kolkata-700017



REGENT EDUCATION & RESEARCH FOUNDATION GROUP OF INSTITUTIONS

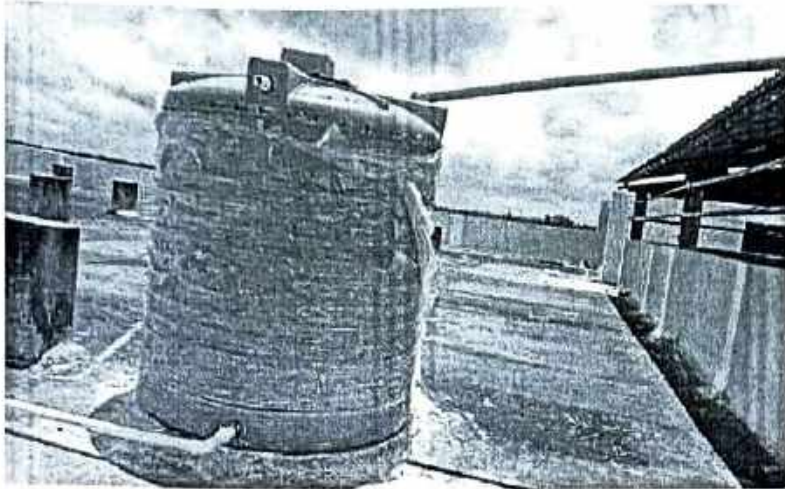

Rain Water Collected in Tank

Objectives:

- To increase recharge of groundwater by capturing and storing rainwater, by rainwater harvesting from rooftop run-offs.
- To store the water for gardening & washing purpose.

Need for rainwater harvesting -

- Increasing water demand The rapid rise in human population has made optimum use of fresh water imperative.
- Urban water supply systems in particular are under tremendous pressure to meet the needs of the population as well as industry and large-scale construction.
- The increased need for water results in lower groundwater levels and depleted reservoirs.
- Consumption of polluted water creates health hazards.
- The use of rainwater is a useful alternative

Responsibilities towards protecting Nature -

- Using more of rainwater helps to conserve & augment the storage of ground water
- It helps to arrest sea water intrusion in coastal areas
- It helps to avoid flood & water stagnation in urban areas
- Reduces water and electricity bills

DR. RAJORSHI BANDYOPADHYAY, (Principal)
REGENT EDUCATION & RESEARCH FOUNDATION
Bara Kathalia, Sweli Telinipara
Barrckpore, Kolkata - 700121

Campus: Regent Education & Research Foundation Group of Institutions

E-mail: rerfolkata@gmail.com, Website: www.rerf.in

Campus Address:

BaraKanthalia, Barrackpore
P.O: Sewli Telinipara,
P.S.: Titagarh, Kolkata - 700121
Tel.: 033-3008-5442/432/431, Fax: 033-3008-5442

Regd. Office Address:

11/3, Biresw Guha Street
7th Floor, Kolkata-700017



REGENT EDUCATION & RESEARCH FOUNDATION GROUP OF INSTITUTIONS

Advantage of collection and storage near the place of use -

- Collecting and storing water close to households improves the accessibility and convenience of water supplies.
- It costs less to collect rainwater than to exploit groundwater.
- Only traditional knowledge, skills and materials can be used to collect the water and no government technical assistance is required for repair and maintenance.
- Collecting rainwater is the only way of recharging water sources and revitalizing dry open wells

Typical details for Rain Water harvesting tanks and systems: -

Schematic Flowchart of Rainwater Utilization Project in RERFGI Campus

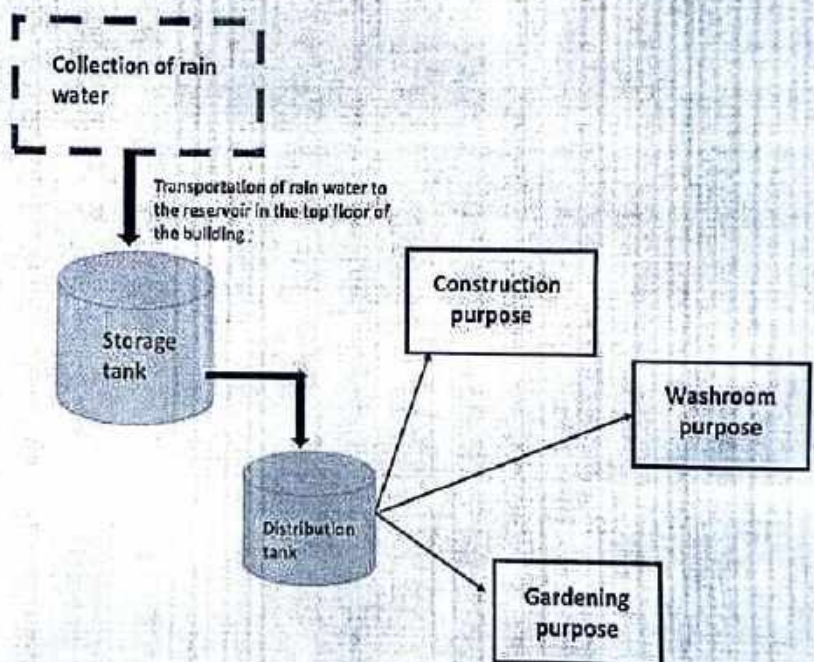

Total catchment area

- Length : 40.60 m
- Width: 20.60 m
- Area: 836.66 Sq.m

Useable rainfall = 1024.54 m³
= 1024540 liters/year

DR. RAJORSHI BANDYOPADHYAY, (Principal)
REGENT EDUCATION & RESEARCH FOUNDATION
Bara Kathalia, Sweli Telinipara
Barrackpore, Kolkata - 700121.

Campus: Regent Education & Research Foundation Group of Institutions

E-mail: rerrkolkata@gmail.com, Website: www.rerrf.in

Campus Address:

BaraKanthalia, Barrackpore
P.O: Sewli Telinipara,
P.S.: Titagarh, Kolkata - 700121
Tel.: 033-3008-5442/432/431, Fax: 033-3008-5442

Regd. Office Address:

11/3, Biresh Guha Street
7th Floor, Kolkata - 700017



REGENT EDUCATION & RESEARCH FOUNDATION GROUP OF INSTITUTIONS

Practice:

- > In the RERFGI campus rainwater harvesting system has been installed on the roof of exactly 836.36 m² of the shade area of the rooftop. The rainwater is collected through a network of pipelines and stored in the tank. There are two 5000 liters tanks on the campus rooftop where the roof runoff water is stored. The roof runoff water is allowed to use for washrooms, Gardening, and construction purposes. Total Area of tin shade of rooftop in RERF 836.36 m². Our civil Engineering departmental students was involved in this project. A budget proposal was Rs 4,00,000 and subsequent approval of institute authority was Rs 337881.50 (Rupees Three lakhs thirty seven thousand eight hundred eighty one and paisa fifty)

Area m ²	Average Depth of Rainfall (m) *	volume of Runoff m ³	30 % losses	Total Quantity m ³
836.36	1.75	1463.63	439.09	1024.54

* Reference -

(<https://wbindustries.gov.in/Climate.html#:~:text=Most%20of%20the%20annual%20average,plains%20and%20western%20plateau%20region>)

- > Useable rainfall = 1024.54 m³ = 1024540 liters/year

DR. RAJORSHI BANDYOPADHYAY, (Principal)
REGENT EDUCATION & RESEARCH FOUNDATION
Bara Kathalia, Sweli Telinipara
Barrackpore, Kolkata - 700121.

Campus: Regent Education & Research Foundation Group of Institutions

E-mail: rerfkolkata@gmail.com, Website: www.rerf.in

Campus Address:

BaraKanthalia, Barrackpore
P.O: Sewli Telinipara,
P.S.: Titagarh, Kolkata - 700121
Tel.: 033-3008-5442/432/431, Fax: 033-3008-5442

Regd. Office Address:

11/3, Biresw Guha Street
7th Floor, Kolkata-700017



REGENT EDUCATION & RESEARCH FOUNDATION GROUP OF INSTITUTIONS

Photography of Rainwater Harvesting Project

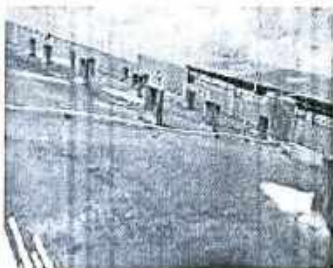

DR. RAJORSHI BANDYOPADHYAY, (Principal)
REGENT EDUCATION & RESEARCH FOUNDATION
Bara Kathalia, Sweli Telinipara
Barrckpore, Kolkata - 700121

Campus: Regent Education & Research Foundation Group of Institutions

E-mail: rerfkolkata@gmail.com, Website: www.rerf.in

Campus Address:

Bara Kanthalia, Barrackpore
P.O: Sewli Telinipara,
P.S.: Titagarh, Kolkata - 700121
Tel.: 033-3008-5442/432/431, Fax: 033-3008-5442

Regd. Office Address:

11/3, Biresh Guha Street
7th Floor, Kolkata - 700017



REGENT EDUCATION & RESEARCH FOUNDATION GROUP OF INSTITUTIONS

Materials Required For Rainwater Harvesting System and Cost

QUOTATION					
To		OUR REF.:-	55/Q-21/2023-24		
REGENT EDUCATION & RESEARCH FOUNDATION		DATE:	05-07-2023		
BARA KANTHALIA, BARRACKPORE		YOUR REF.:-	What's app		
Site:- BARA KANTHALIA, BARRACKPORE		DATE:	05-07-2023		
Sl.No.	MATERIALS DESCRIPTION	QTY.	UNIT	NET RATE	AMOUNT
1	5000 Ltr. (Four layer Foam) Water Tank (Rel. Classic)	2	Pcs.	38000.00	76000.00
2	2000 Ltr. (Four layer Foam) Water Tank (Rel. Classic)	4	Pcs.	15600.00	62400.00
3	1½" UPVC Tank Connector	14	Pcs.	67.00	938.00
4	1½" UPVC Ball Valve	8	Pcs.	390.00	3120.00
5	1½" UPVC Elbow	135	Pcs.	54.00	7290.00
6	1½" UPVC Tee	30	Pcs.	80.00	2400.00
7	1½" UPVC Passover	10	Pcs.	177.00	1770.00
8	1½" UPVC China Clamp	180	Pcs.	11.00	1980.00
9	1½" UPVC 45° Elbow	18	Fl.	42.00	756.00
10	1½" UPVC Socket	98	Pcs.	31.00	3038.00
11	1½" X 1" UPVC Reducing Socket	35	Pcs.	32.00	1120.00
12	1½" X 1½" UPVC Reducing Socket	8	Pcs.	33.00	264.00
13	1½" X 1" UPVC Reducing Elbow	30	Pcs.	69.00	2070.00
14	1½" X 1" UPVC Reducing Tee	25	Pcs.	57.00	1425.00
15	1½" UPVC End Cap	12	Pcs.	22.00	264.00
16	1½" UPVC Pipe	950	Fl.	49.00	46550.00
17	1½" PVC Ball Cock	10	Pcs.	905.00	9050.00
18	250ml UPVC Solvent Cement	38	Pcs.	225.00	8550.00
19	1" UPVC Pipe	760	Fl.	29.00	22040.00
20	1" UPVC Elbow	95	Pcs.	23.50	2232.50
21	1" UPVC Tee	28	Pcs.	32.00	896.00
22	1" UPVC Socket	50	Pcs.	19.00	950.00
23	1" X ¾" UPVC Reducing Elbow	38	Pcs.	21.00	798.00
24	1" X ¾" UPVC Reducing Tee	12	Pcs.	33.00	396.00
25	1" X ½" UPVC Reducing Elbow (Metal)	24	Pcs.	90.00	2160.00
26	1" X ½" UPVC Reducing Tee (Metal)	14	Pcs.	122.00	1708.00
27	1" UPVC Ball Valve	28	Pcs.	240.00	6720.00
28	1" UPVC China Clamp	210	Pcs.	8.50	1785.00
29	¾" UPVC Pipe	130	Fl.	20.00	2600.00
30	110mm X 10' PVC Pipe 5/5	30	Pcs.	520.00	15600.00
31	110mm PVC End Cap	12	Pcs.	56.00	672.00
32	1" X 1" UPVC Elbow (Metal)	12	Pcs.	210.00	2520.00
33	Teflon Tape	48	Pcs.	25.00	1200.00
34	250gm. BOND SET (M-seal)	18	Pcs.	75.00	1350.00
35	1½" C.I. Hook	36	Pcs.	11.50	414.00
36	¾" UPVC Ball Valve	25	Pcs.	140.00	3500.00
37	¾" UPVC China Clamp	42	Pcs.	7.50	315.00
38	Tap	30	Pcs.	400.00	12000.00
39	Tank connector	1	Pcs.	400.00	400.00
40	Service & Labour Charge			7700	7700
(including GST) SUB TOTAL AMOUNT (NET)					337881.50
Discount on Labour Charge					7700
Total Amount					337881.50

DR. RAJORSHI BANERJEE (Principal)
REGENT EDUCATION & RESEARCH FOUNDATION
Bara Kanchalia, Swelli Telinipara
Barrackpore, Kolkata

Campus: Regent Education & Research Foundation Group of Institutions

E-mail: rerkolkata@gmail.com, Website: www.rerf.in

Campus Address:

Bara Kanchalia, Barrackpore
P.O.: Sewli Telinipara,
P.S.: Titagarh, Kolkata - 700121
Tel.: 033-3008-5442/432/431, Fax: 033-3008-5442

Regd. Office Address:

11/3, Biresha Guha Street
7th Floor, Kolkata-700017



REGENT EDUCATION & RESEARCH FOUNDATION GROUP OF INSTITUTIONS

PROJECT ON
AUTOMATIC SOLAR STREET LIGHT

REGENT EDUCATION AND RESEARCH FOUNDATION
GROUP OF INSTITUTIONS



Prepared by : Electrical and Electronics Engineering Department

Dr. Suman Kumar Dey
Assistant Professor
Principal Investigator
Department of Electrical and Electronics Engineering

Bidyut Kumar Ghosh
Assistant Professor
Co- Principal Investigator
Department of Electrical and Electronics Engineering

Dr. Rajorshi Bandyopadhyay
Principal of RERFGI



Campus: Regent Education & Research Foundation Group of Institutions

E-mail: rerf.kolkata@gmail.com, Website: www.rerf.in

Campus Address: Bara Kanth
alia, Barrackpore P.O: Sewli
Telinipara,
P.S.: Titagarh Kolkata-
700121

Regd. Office Address: 11/3,
Bireswari Street 7th Flo
or, Kolkata-700017



REGENT EDUCATION & RESEARCH FOUNDATION GROUP OF INSTITUTIONS

Name of Students Involved in the project

Name	Roll No
Akash Das	26301620007
Sourav Biswas	26301620009
Biswajit Sarkar	26301620017
Arka Banik	26301621041
Subhajit Nath	26300720018

A. Das
S. Biswas
B. Sarkar
A. Banik
S. Nath

[Handwritten Signature]



Campus: Regent Education & Research Foundation Group of Institutions

E-mail: rerf.kolkata@gmail.com, Website: www.rerf.in

Campus Address: Bara Kanth
alla, Barrackpore P.O: Sewli
Telinipara,
P.S.: Titagarh Kolkata-
700121

Regd. Office Address: 11/3,
Biresh Guha Street 7th Flo
or, Kolkata-700017



AUTOMATIC SOLAR STREET LIGHT

Introduction

Since people have been coexisting, there has been street lights. Ancient Romans used oil lamps filled with vegetable oil in front of their homes as early as 500 BC. William Murdock utilized a coal gas-powered gas light in 1802. Soon after, in 1807, the English city of London made the decision to employ gas lights to illuminate a full street rather than simply the fronts of homes. These gas lamps were first used in the United States in 1816, though. The first city to use gas lights was Baltimore, Maryland. Improvements were made to the gas lights, and the more energy-efficient electric lights were switched in their place.

The first electric street light to use arc lamps was the Yablochkov Candle, created by Pavel Yablochkov in 1875. In Paris, France, three years later, the city started replacing the gas lamps with electric ones and had already replaced roughly 4,000 street lights. In response, 130,000 arc lighting were placed on numerous city streets in the United States by 1890. Once electric street lights were introduced, advancements were made gradually. There are many different lights available today. Many conventional street lights are energy efficient, but some extremely old street lights that are still in use are not. If the systems are configured properly, solar photovoltaic street lighting have the potential to be very energy-efficient. The differences between conventional and solar illumination will be discussed.

Contrary to typical street lighting, solar street lighting is a relatively new invention. There is no electrical power grid connection for these street lights; instead, the solar light will generate its own energy from the sun (photovoltaic panel) and store it in a battery until it is sufficiently dark for the light to turn on. Off-grid solar illumination applications come in a variety of forms. A micro grid, which is effectively a miniature power grid used only for the lights, is one way the solar panels can be connected. Another option is for each street light to operate independently.

Solar photovoltaic technology uses an electronic process that takes place in specific materials known as semiconductors to produce power directly from sunshine. Nowadays, thin-film semiconductors or crystalline silicon are used to make the majority of solar cells. Although expensive, silicon has been found to be quite effective at turning sunlight into power. Thin-film materials are occasionally utilized because they are more affordable. The drawback is that these materials need greater surface area to generate electricity and are less efficient than silicon.

Proposed system for Trial:

Our proposed system is sub divided into four sections:

1. Solar Panel
2. Control Unit
3. Battery storage unit
4. DC Light.

During the day time solar panel receives its I/P from the Sun rays. At the same time the control unit is also functioning for charging the battery and giving the over voltage protection also. At sunset Solar panel is unable to receive the I/P from the sun and the light will be functioned through control unit.

When the battery storage unit is reaches to 90% discharge condition, the storage unit will be automatically disconnected and light will remain ON condition through the main power supply. This action is also being performed by the control unit.

Again, during the time of Sunrise, the light will be going to OFF condition through control unit and the battery will get charged and the cycle is going on.

Campus: Regent Education & Research Foundation Group of Institutions

E-mail: rerfholkatn@gmail.com Website: www.rerf.in

Principle



Campus Address: Baran Kanth
alia, Barrackpore P.O: Sewli
Telinipara,
P.S.: Titagarh Kolkata-
700121

Regd. Office Address: 11/3,
Biresh Guba Street 7th Flo
or, Kolkata-700017



Block Diagram:

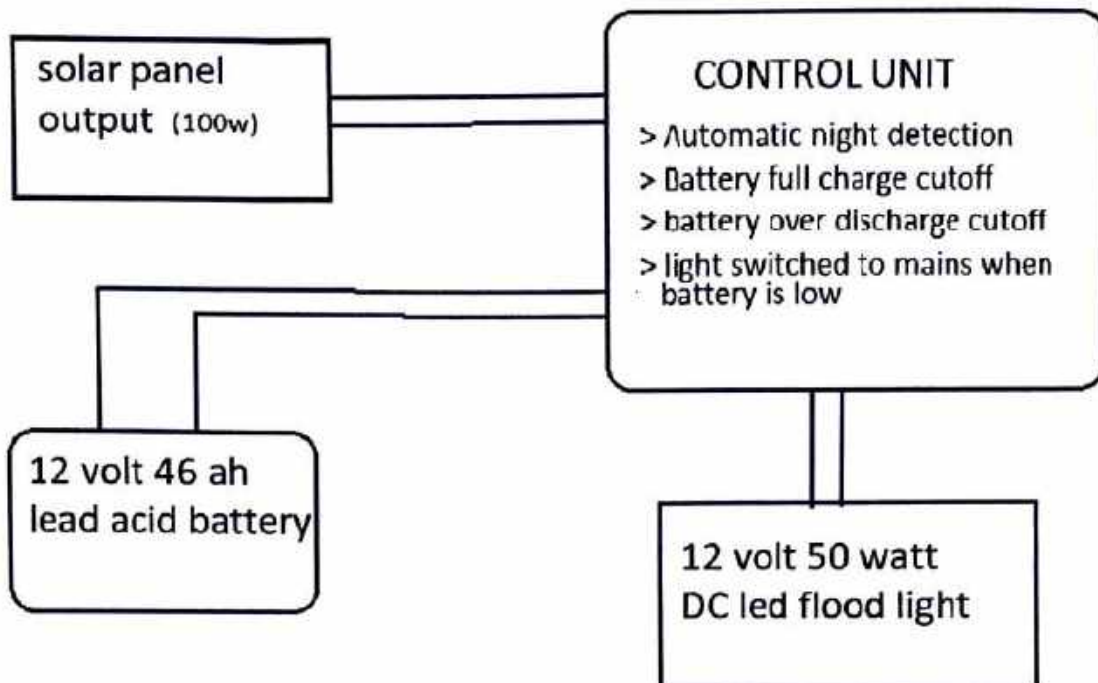

Cost:

SL.NO	APPARATUS NAMES	APPARATUS QUANTITIES	APPARATUS PRICES (in Rs.)
01	JUNCTION BOX	1	55
02	VERO BOARD	1	55
03	CONNECTER	4	52
04	555-IC	1	24
05	TRANSISTER	4	20
06	VR POT	4	25
07	INDICATOR LEDS	5	20
08	RELAY	2	50
09	WIRES		50
10	DC LED (25W)	2	300
11	MAKING COST		100
12	SMPS	1	500
13	NUTSPSCURES		50
14	BATTERY	12V 42AH	4000
TOTAL PRICES (in Rs.)			5301

Conclusion

By this project, we are trying to establish an approach through which we are provided hands on training of our students to the renewable energy as well as make our campus green. Definitely the initial cost of this type flood lighting system is higher in comparison with traditional flood lighting system type flood lighting system is higher

Campus: Regent Education & Research Foundation Group of Institutions

E-mail: rerfkolkata@gmail.com, Website: www.rerf.in

Campus Address: BaraKanth
alia, Barrackpore P.O: Sewli
Telinipara,
P.S.: Titagarh Kolkata-
700121

Regd. Office Address: 11/3,
Biresh Guha Street 7th Flo
or, Kolkata-700017

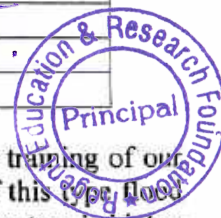



REGENT EDUCATION & RESEARCH FOUNDATION GROUP OF INSTITUTIONS

in comparison with traditional flood lighting system. But cost associated with energy consumption will be affected to some extent.

Last but not the least it should be mentioned that this system is implemented in trial basis but in future we will trying to cover all the flood lighting of our campus under this category.

Reference

- <https://inhabitat.com/sandia-solar-glitter-can-fit-into-and-power-devices-of-any-size-or-shape/>
- http://www.lrc.rpi.edu/programs/NLPIP/PDF/VIEW/SR_StreetlightsLocal.pdf
- <http://blog.lightinus.com/comparing-traditional-street-lights-and-solar-energy-lights>
- <https://www.engoplanet.com/single-post/COMPARING-COST-TRADITIONAL-STREET-LIGHTS-VSSOLAR-POLES>
- <http://www.geni.org/globalenergy/research/renewable-energy-on-tribal-lands/RenewableEnergy-on-Tribal-Lands.pdf>
- <http://www.renewableenergyworld.com/geothermal-energy/tech/geoelectricity.html>
- <http://www.homeadvisor.com/cost/heating-and-cooling/install-a-geothermal-heating-or-cooling-system/>
- <https://www.engoplanet.com/single-post/Cost-Comparison-Solar-LED-lights-traditional>
- <https://www.firstenergycorp.com/content/dam/customer/get-help/files/savingenergy/pastreetlights/ledfactsheet-cobrahead-pn.pdf>

Geo-Tagged Image:



Campus: Regent Education & Research Foundation Group of Institutions

E-mail: rerrfolkata@gmail.com, Website: www.rerf.in

Campus Address: BaraKanth
alia, Barrackpore P.O: Sewli
Telinipara,
P.S.: Titagarh Kolkata-
700121

Regd. Office Address: 11/3,
Biresh Guha Street 7th Flo
or, Kolkata-700017



REGENT EDUCATION & RESEARCH FOUNDATION GROUP
OF INSTITUTIONS

PROJECT ON
TRAFFIC BLINKER LIGHT BY SOLAR SYSTEM
REGENT EDUCATION AND RESEARCH FOUNDATION
GROUP OF INSTITUTIONS



Prepared by : Electrical Engineering Department

Bidyut Kumar Ghosh
Assistant Professor
Principal Investigator
Department of Electrical Engineering

Sanjib Paul
Assistant Professor
Co- Principal Investigator

Dr. Rajorshi Bandyopadhyay
Principal of REEF



Campus: Regent Education & Research Foundation Group of Institutions

E-mail: rerfkolkata@gmail.com, Website: www.rerf.in

Campus Address: BaraKanth
alia, Barrackpore P.O: Sewli
Telinipara,
P.S.: Titagarh Kolkata-
700121

Regd. Office Address: 11/3,
Bireswari Street 7th Flo
or, Kolkata-700017



Name of Students Involved in the project

1. Sayan Saha	Sayan Saha
2. Somnath Roy	S. Roy
3. Subhajit Ghosh	Subhajit Ghosh
4. Avro Adhikary	A. Adhikary
5. Santanu Roy	S. Roy
6. Monajit Bhadra	M. Bhadra
7. Soumya Kolay	Soumya Kolay

[Handwritten signature]



Campus: Regent Education & Research Foundation Group of Institutions

E-mail: rerkolkata@gmail.com, Website: www.rerf.in

Campus Address: Bara Kanth
alia, Barrackpore P.O: Sewli
Telinipara,
P.S.: Titagarh Kolkata-
700121

Regd. Office Address: 11/3,
Bireswari Street 7th Flo
or, Kolkata-700017



TRAFFIC BLINKER LIGHT by SOLAR SYSTEM

Introduction

Traffic Blinker Light is an autonomous LED Flashing system. Its purpose is to warn motorists and emphasize them to speed control when reach close to school, fire station, military zone, village road, small town, pedestrian cross walk, diversions, blind or sharp turns where the motorists are unable to judge the route or direction and severe hazard ahead. It blinks (flash) at specified rate (can be customised).

However, these signals come with some rules associated with them. Basically, the traffic signal rules form the very backbone of these signs and following them is vital for ensuring smooth and risk-free road travel. A traffic signal is used as an instructing device that indicates the road user to act according to the displayed sign. Following the traffic signal ensures road safety and to make things simple to understand, these signals have been using a universal colour code.

In recent years, with the rapid growth of private car, urban road transportation load enlarges suddenly and many roads' sections approach to saturated limit in peak time interval. Traffic congestion has been the universal problem for most big cities. Traffic congestion is one of the worldwide urban problems, which can lengthen journey time, increase energy consumption, aggravate environmental pollution and result in traffic accident. If we take no measure to govern it, not only individual journey cost will be enhanced, but also the entire municipal transportation system will paralyse and urban sustainable development will be restricted. Therefore, how to solve traffic congestion becomes the hot issue for each big city.

The essence of traffic congestion is the unbalance transportation of supply and demand. Increasing road supply is one kind of solutions to alleviate supply and demand contradictory. However, practices coming from various countries indicated that dependence on constructing more roads would inevitably result in the vicious circle of "traffic congestion - road building - congestion alleviation - attracting more transportation demand - producing new congestion - building more roads", which could not truly solve the traffic congestion problem. Therefore, more and more experts hope to find new breach from the demand management aspect and have proposed many demand management methods, in which traffic congestion charging as one of the effective measures has aroused widespread interest in city administration department.

Proposed System design & Operation:

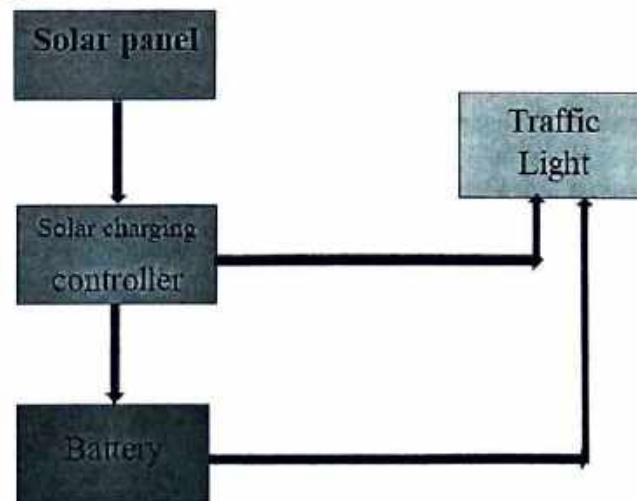

The solar panel receives the sunlight to generate electricity, and the controller of which is used for battery charging. The controller has functions of preventing inverted connection, inverted charging, excessive discharge.

Campus: Regent Education & Research Foundation Group of Institutions

E-mail: rerfkolkata@gmail.com, Website: www.rerf.in

Campus Address: BaraKanth
alia, Barrackpore P.O: Sewli
Telinipara,
P.S.: Titagarh Kolkata-
700121

Regd. Office Address: 11/3,
Biresh Guha Street 7th Flo
or Kolkata - 700017

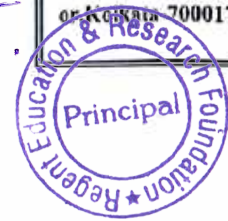



REGENT EDUCATION & RESEARCH FOUNDATION GROUP OF INSTITUTIONS

overcharging and overloading and automatic protection for short circuit, boasting features such as automatic identification of day and night, automatic detection of voltage, automatic storage battery protection, easy installation and no pollution. The battery discharges electricity to the signal machine, transmitter, receiver and signal light via the controller.

Cost:

SL.NO	APPARATUS NAMES	APPARATUS QUANTITIES	APPARATUS PRICES (in Rs.)
01	SOLAR PANEL	1	600
02	CHARGE CONTROLLER	1	800
03	BATTERY	1	1500
04	RELAY	1	200
05	SIGNAL LIGHT	1	2000
06	POLE	1	2300
07	BATTERY MOUNTING BOX	1	500
TOTAL PRICES (in Rs.)			7900

Conclusion

By this project, we are trying to establish an approach through which we are provided hands on training of our students to the renewable energy as well as make our campus green. In old scenario by making the poster or painting we have to intimate that school or college ahead. By implementing this project, we are conveying the same message digitally i.e., through signal.

Reference

- [1] ELECTRONIC TRAFFIC SIGNAGE & EL SEGUNDO, CA US, "An illuminated display apparatus for supplementing street signals includes a housing containing an LED array capable of producing multicoloured and animated images, a bracket system holding the housings together wherein a row of multiple housings and LED arrays may be assembled together to create larger displays, and wherein a system of brackets supports the housings at an angle from vertical for viewing by passing vehicles below. The display may also include a solar array, loudspeakers, strobe apparatus and automatic brightness dimming."
- [2] Emergency traffic light system & EL SEGUNDO, CA US, "A supplemental system of stop lights for use in conjunction with a primary stop light system. Solar powered supplemental stop light units are mechanically attached nearby the stop light units of the primary system. Should the primary system fail, the supplemental stop lights become active to re-establish control of the traffic flow and substitute for the disabled primary stop light system. The supplemental stop light system uses at least two visual displays: a graphics display and an alphanumeric verbal display. In an alternative use in conjunction with emergency vehicle traffic, an alphanumeric numeric display can be advantageously."



Campus: Regent Education & Research Foundation Group of Institutions

E-mail: rerfkolkata@gmail.com, Website: www.rerf.in

Campus Address: BaraKanth
alia, Barrackpore P.O: Sewli
Telinipara,
P.S.: Titagarh Kolkata-
700121

Regd. Office Address: 11/3,
Bires Ghosh Street 7th Flo
or, Kolkata-700017



REGENT EDUCATION & RESEARCH FOUNDATION GROUP OF INSTITUTIONS

Geo-Tagged Image:

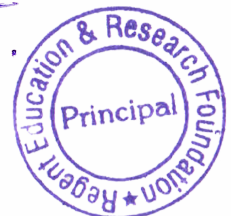

Campus: Regent Education & Research Foundation Group of Institutions

E-mail: rerfkolkata@gmail.com, Website: www.rerf.in

Campus Address: Bara Kanthalia, Barrackpore P.O: Sewli Telinipara, P.S.: Titagarh Kolkata-700121

Regd. Office Address: 11/3, Biresh Guha Street 7th Floor, Kolkata-700017



REGENT EDUCATION & RESEARCH FOUNDATION GROUP OF INSTITUTIONS



NSS Cell
**Maulana Abul Kalam Azad University of
Technology, West Bengal**



NOTICE

DATE 03/06/2022

THIS IS FOR THE INFORMATION OF ALL THAT NSS CELL OF RERF IS GOING TO ORGANISE WORLD ENVIRONMENT DAY ON 05/06/2022 IN ONLINE MODE TO CELEBRATE AND CREATE AWARENESS ON THE URGENT NEED TO PROTECT OUR ENVIRONMENT.

THEREFORE, ALL STUDENTS, TEACHING AND NON-TEACHING STAFF MEMBERS OF RERFGOI ARE REQUESTED TO KINDLY PARTICIPATE IN THE WORLD ENVIRONMENT DAY EVENT ON 05/06/2022 2022 IN ONLINE MODE

THE ONLINE EVENT WILL BE HELD IN THE FOLLOWING LINK
meet.google.com/fep-jxwp-jyb

TIMING OF THE EVENT: 9:30 AM TO 10:30 AM

SIGNATURE OF PROGRAM OFFICER

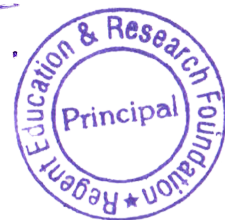

Campus : Regent Education & Research Foundation Group of Institutions

E-mail : rerfkolkata@gmail.com, Website : www.rerf.in

Campus Address:

Bara Kanthalia, Barrackpore
P.O: Sewli Telinipara, P.S.: Titagarh
Kolkata - 700 121
Tel.: 033-3008-5442/432/431, Fax: 033-3008-5442

Regd. Office Address:

11/3, Biresh Guha Street
7th Floor, Kolkata - 700 017
Tel.: 033-3221-3013



REGENT EDUCATION & RESEARCH FOUNDATION GROUP OF INSTITUTIONS

Webinar On
"Sustainable Development & Environment"

RESOURCE PERSON:

Organized By
NSS Cell in collaboration with BSH Department
Regent Education & Research Foundation
Group of Institutions

Platform
GOOGLE MEET

5th June, 2022
9:30 AM onwards

Google Meet Link: <https://meet.google.com/fep-jxwp-jyb>

E-Certificate will be provided on sending the Feedback Form



Campus : Regent Education & Research Foundation Group of Institutions

E-mail : rerfkolkata@gmail.com, Website : www.rerf.in

Campus Address:

Bara Kanthalia, Barrackpore
P.O: Sewli Telinipara, P.S.: Titagarh
Kolkata - 700 121
Tel.: 033-3008-5442/432/431, Fax: 033-3008-5442

Regd. Office Address:

11/3, Biresh Guha Street
7th Floor, Kolkata - 700 017
Tel.: 033-3221-3013



REGENT EDUCATION & RESEARCH FOUNDATION GROUP OF INSTITUTIONS

Title of the Practice: World Environment Day Celebration

World Environment Day, observed on 5th June, is the United Nations' primary platform for promoting awareness and action towards environmental protection. Since its inception in 1973, it has played a crucial role in raising awareness about various environmental issues such as marine pollution, overpopulation, global warming, sustainable development, and wildlife crime. World Environment Day serves as a global platform for public outreach, with participation from numerous countries annually. It provides an opportunity for businesses, non-governmental organizations, communities, governments, and celebrities to advocate for environmental causes and promote green practices.

Objectives of the practice:

The objectives of the World Environment Day celebration by the NSS unit of RERFGOI in collaboration with the BSH department were as follows:

- Raise awareness about sustainable development and environmental conservation among students and volunteers.
- Provide a platform for knowledge sharing and learning from experts in the field.
- Promote the importance of environmental protection and the role of individuals and communities in preserving the environment.
- Encourage participants to take proactive actions towards creating a sustainable and eco-friendly future.
- Foster a sense of responsibility and commitment to environmental stewardship.

The Context

World Environment Day serves as a significant global event aimed at generating awareness and action for environmental conservation. The celebration of this day provides an opportunity to highlight the importance of environmental sustainability and mobilize individuals and communities towards adopting environmentally friendly practices. The NSS unit of RERFGOI, in collaboration with the BSH department, organized a webinar on 'Sustainable Development and Environment' to mark this occasion.

The Practice:

The NSS unit of RERFGOI, in collaboration with the BSH department, conducted a webinar on 'Sustainable Development and Environment' to commemorate World Environment Day. The webinar was held on 5th June at 9:30 a.m. and took place on the Google Meet platform. The event commenced with an inauguration by Mr. Subhankar Ghosh (Registrar, RERF) and Mr. Swadhin Chakrabarty (Programme Officer, NSS Unit, RERF). The key speaker for the webinar was Dr. Indranil Ghosh (Associate Professor, Netaji Subhas Engineering College), who delivered an enriching speech on sustainable development and environmental conservation.

Campus : Regent Education & Research Foundation Group of Institutions

E-mail : rerfkolkata@gmail.com, Website : www.rerf.in

Campus Address:

**Bara Kanthalia, Barrackpore
P.O: Sewli Telinipara, P.S.: Titagarh
Kolkata - 700 121
Tel.: 033-3008-5442/432/431, Fax: 033-3008-5442**

Regd. Office Address:

**11/3, Biresh Guha Street
7th Floor, Kolkata - 700 017
Tel.: 033-3221-3013**



REGENT EDUCATION & RESEARCH FOUNDATION GROUP OF INSTITUTIONS

Evidence of Success:

The webinar witnessed active participation from approximately 60 students and 10 NSS volunteers. The audience engaged in the session, gaining valuable insights into sustainable development and environmental issues. The keynote speech delivered by Dr. Indranil Ghosh proved to be highly informative and thought-provoking, stimulating discussions among the participants. The event successfully achieved its objective of raising awareness and promoting understanding about sustainable development and the importance of environmental conservation.

Problems encountered :

During the organization of the webinar for World Environment Day, a few challenges were encountered, including:

- Technical difficulties or connectivity issues that may have affected the smooth conduct of the webinar.
- Ensuring effective coordination and communication with the participants before and during the event.
- Availability of suitable resources and materials for promoting sustainable development and environmental conservation.

Resources Required:

To successfully organize the webinar on World Environment Day, the following resources were required:

- Access to a reliable internet connection and the necessary technological infrastructure to conduct the webinar.
- Collaboration and support from the BSH department and NSS unit of RERFGOI.
- Expertise and availability of Dr. Indranil Ghosh as the keynote speaker.
- Adequate promotional materials and resources to generate awareness and encourage participation.

Conclusion:

The celebration of World Environment Day through the webinar on 'Sustainable Development and Environment' by the NSS unit of RERFGOI in collaboration with the BSH department proved to be a successful and impactful initiative. The event effectively raised awareness about sustainable development, environmental conservation, and the importance of individual and collective action. Despite the challenges faced, the program witnessed active participation, fostering a sense of responsibility towards environmental stewardship among the students and volunteers.



Campus : Regent Education & Research Foundation Group of Institutions

E-mail : rerfkolkata@gmail.com, Website : www.rerf.in

Campus Address:

Bara Kanthalia, Barrackpore
P.O: Sewli Telinipara, P.S.: Titagarh
Kolkata - 700 121
Tel.: 033-3008-5442/432/431, Fax: 033-3008-5442

Regd. Office Address:

11/3, Biresh Guha Street
7th Floor, Kolkata - 700 017
Tel.: 033-3221-3013



REGENT EDUCATION & RESEARCH FOUNDATION GROUP OF INSTITUTIONS



Handwritten signature in blue ink



Campus : Regent Education & Research Foundation Group of Institutions

E-mail : refkolkata@gmail.com, Website : www.ref.in

Campus Address:

Bara Kanthalia, Barrackpore
P.O: Sewli Telinipara, P.S.: Titagarh

Kolkata - 700 121

Tel.: 033-3008-5442/432/431, Fax: 033-3008-5442

Regd. Office Address:

11/3, Biresh Guha Street
7th Floor, Kolkata - 700 017

Tel.: 033-3221-3013



REGENT EDUCATION & RESEARCH FOUNDATION GROUP OF INSTITUTIONS



NSS Cell
**Maulana Abul Kalam Azad University of
Technology, West Bengal**



NOTICE

DATE 11/03/2023

THIS IS FOR THE INFORMATION OF ALL THAT NSS CELL OF RERF IS GOING TO ORGANISE TREE PLANTATION ON 22/03/2023.

THEREFORE, ALL STUDENTS, TEACHING AND NON-TEACHING STAFF MEMBERS OF RERFGOI ARE REQUESTED TO KINDLY PARTICIPATE IN THE TREE PLANTATION EVENT ON 22/03/2023.

TIMING OF THE EVENT: 11: 00 AM ONWARDS

SIGNATURE OF PROGRAM OFFICER

Principal
Regent Education & Research Foundation
Bara Kanthalia, P.O. -Sewli Telinipara
Barrackpore, Kolkata- 700121

Campus : Regent Education & Research Foundation Group of Institutions

E-mail : rerfkolkata@gmail.com, Website : www.rerf.in

Campus Address:

Bara Kanthalia, Barrackpore
P.O: Sewli Telinipara, P.S.: Titagarh
Kolkata - 700 121
Tel.: 033-3008-5442/432/431, Fax: 033-3008-5442

Regd. Office Address:

11/3, Biresh Guha Street
7th Floor, Kolkata - 700 017
Tel.: 033-3221-3013



REGENT EDUCATION & RESEARCH FOUNDATION GROUP OF INSTITUTIONS

राष्ट्रीय सेवा योजना
National Service Scheme
युवा कार्यक्रम और खेल मंत्रालय
Ministry of Youth Affairs and Sports
भारत सरकार
Government of India

IQAC

**TREE PLANTATION AND
CLEAN INDIA CELEBRATION
22nd MARCH, 2023
(11.00AM)**

Organized By

**REGENT EDUCATION & RESEARCH FOUNDATION
GROUP OF INSTITUTIONS,
BARRACKPORE, KOL-121**

Principal
Regent Education & Research Foundation
Bara Kanthalia, P.O. - Sewli Telinipara
Barrackpore, Kolkata- 700121

Campus : Regent Education & Research Foundation Group of Institutions

E-mail : refkolkata@gmail.com, Website : www.ref.in

Campus Address:

Bara Kanthalia, Barrackpore
P.O: Sewli Telinipara, P.S.: Titagarh
Kolkata - 700 121
Tel.: 033-3008-5442/432/431, Fax: 033-3008-5442

Regd. Office Address:

11/3, Biresh Guha Street
7th Floor, Kolkata - 700 017
Tel.: 033-3221-3013



REGENT EDUCATION & RESEARCH FOUNDATION GROUP OF INSTITUTIONS

Title of the Practice: Tree Plantation Celebration

Objectives of the practice:

When you plant a tree, you don't just plant a sapling but hope. We have learned it the hard way that trees are extremely important for our survival. We first resorted to deforestation and made space for more buildings on earth. Later, when we saw the environment getting seriously affected, we were introduced to something called "afforestation", a simple process of planting more trees for a better future

The Context

Thus, we have our global Tree Plantation Day which is celebrated on 21st March all over the world. The aim behind observing the said day is to make people aware of the importance of planting trees and help them realize the same. A common practice during tree plantation day is to plant saplings in order to invest in the future

The Practice:

"Cleanliness is next to Godliness." To contribute in swachh bharaat abhiyan activity & undertake cleanliness drive. It is everybody's responsibility and one should keep themselves and their surroundings clean and hygienic. It also brings good and positive thoughts in the mind which slows down the occurrence of diseases. It is the mantra of Mahatma Gandhiji, Father of Nation. He demonstrated, propagated and insisted for individual and community cleanliness throughout his life. Following his footprints, Swachh bharaat Mission campaign achieved encouraging results. This vision will be translated into action by bringing in community participation for clean toilets and integrated waste management to make our place open defecation free, zero waste, dust free, plastic free and green. This year, NSS Cell of RERFGOI in association with IQAC cell of RERF organized this event on 22nd March, 2023.. Students have encouraged community people to join in Swachhta activity. They have participated in shramdan activity and shown their willingness and interest to keep surrounding clean.

Evidence of Success:

The Swachh Bharat Abhiyan is the most significant cleanliness campaign by the Government of India. Its' responsibility of the entire citizens to keep their surrounding clean community people were encouraged to maintain their surrounding clean. Thus the students of our college have initiated one steps towards-cleanliness". Around 50 students participated in this event. NSS Cell of RERFGOI in association with IQAC cell of RERF organized this event on 22nd March, 2023.. Students have encouraged community people to join in Swachhta Activity. They have participated in shramdan activity and shown their willingness and interest to keep surrounding clean.

Campus : Regent Education & Research Foundation Group of Institutions

E-mail : rerfkolkata@gmail.com, Website : www.rerf.in

Campus Address:

**Bara Kanthalia, Barrackpore
P.O: Sewli Telinipara, P.S.: Titagarh
Kolkata - 700 121
Tel.: 033-3008-5442/432/431, Fax: 033-3008-5442**

Regd. Office Address:

**11/3, Biresh Guha Street
7th Floor, Kolkata - 700 017
Tel.: 033-3221-3013**



REGENT EDUCATION & RESEARCH FOUNDATION GROUP OF INSTITUTIONS

Problems encountered and resources required:

- A major hurdle in the way is the scarcity of water. Public toilets in metropolitan cities have been reported to have no water supply at all.
- Non-availability of water in many parts of rural India makes people avoid a household or a public toilet and opt for open defecation instead.

Problems encountered:

1. Dust and dirt. Various kinds of trash. In places as huge as stadiums and airports, it's a must to have rubbish bins in every corner.
2. Toilets.
3. Thousands of seats.
4. Floors.

Resources required:

Swachh Bharat Abhiyan is a five year long cleanliness campaign launched by the Government of India on 2nd October 2014. The campaign was aimed for making the streets, roads and offices clean from filth and garbage. One of the main objectives of the drive is to make India Open Defecation Free (ODF). The campaign also targets raising public awareness about cleanliness through rigorous media campaigns and to institute door to door garbage collection in rural/urban household and ensuring its safe disposal

Make the most of the day by working on things that don't get done often, like cleaning the chairs in the auditorium or dusting the tops of lockers. If you like, you could ask for permission to plant some flowers around campus, like in a flower bed near the school's entrance.

Principal
Regent Education & Research Foundation
Bara Kanthalia, P.O. - Sewli Telinipara
Barrackpore, Kolkata- 700121

Campus : Regent Education & Research Foundation Group of Institutions

E-mail : rerfkolkata@gmail.com, Website : www.rerf.in

Campus Address:

Bara Kanthalia, Barrackpore
P.O: Sewli Telinipara, P.S.: Titagarh
Kolkata - 700 121
Tel.: 033-3008-5442/432/431, Fax: 033-3008-5442

Regd. Office Address:

11/3, Biresh Guha Street
7th Floor, Kolkata - 700 017
Tel.: 033-3221-3013



REGENT EDUCATION & RESEARCH FOUNDATION GROUP OF INSTITUTIONS



Principal
Regent Education & Research Foundation
Bara Kanthalia, P.O.-Sewli Telinipara
Barrackpore, Kolkata- 700121

Campus : Regent Education & Research Foundation Group of Institutions

E-mail : rerfolkata@gmail.com, Website : www.rerf.in

Campus Address:

Bara Kanthalia, Barrackpore
P.O: Sewli Telinipara, P.S.: Titagarh
Kolkata - 700 121
Tel.: 033-3008-5442/432/431, Fax: 033-3008-5442

Regd. Office Address:

11/3, Biresh Guha Street
7th Floor, Kolkata - 700 017
Tel.: 033-3221-3013



REGENT EDUCATION & RESEARCH FOUNDATION GROUP OF INSTITUTIONS



CERTIFICATE OF PARTICIPATION

TREE PLANTATION AND CLEAN INDIA CELEBRATION

Organized By

NATIONAL SERVICE SCHEME (NSS)

**Regent Education & Research Foundation Group of Institution, Barrackpore, Kol-121
ON 22nd March, 2023**

This is to certify that

PARTICIPATED IN TREE PLANTATION AND CLEAN INDIA CELEBRATION IN RERFGOI UNDER
NSS CELL, RERF 22.03.2023

MR. PRABAL KUMAR BASAK
CONVENER, IIC, RERFGI

DR. RAJARSHI BANDYOPADHAYA
PRINCIPAL, RERFGI

Principal
Regent Education & Research Foundation
Bara Kanthalia, P.O. - Sewli Telinipara
Barrackpore, Kolkata- 700121

Campus : Regent Education & Research Foundation Group of Institutions

E-mail : rerfkolkata@gmail.com, Website : www.rerf.in

Campus Address:

**Bara Kanthalia, Barrackpore
P.O: Sewli Telinipara, P.S.: Titagarh
Kolkata - 700 121
Tel.: 033-3008-5442/432/431, Fax: 033-3008-5442**

Regd. Office Address:

**11/3, Biresh Guha Street
7th Floor, Kolkata - 700 017
Tel.: 033-3221-3013**



REGENT EDUCATION & RESEARCH FOUNDATION GROUP OF INSTITUTIONS



NSS Cell
**Maulana Abul Kalam Azad University of
Technology, West Bengal**



NOTICE

DATE 11/03/2023

THIS IS FOR THE INFORMATION OF ALL THAT NSS CELL OF RERF IS GOING TO ORGANISE CLEAN INDIA CAMPAIGN ON 22/03/2023 TO CELEBRATE AND CREATE AWARENESS ON CLEAN INDIA CAMPAIGN.

THEREFORE, ALL STUDENTS, TEACHING AND NON-TEACHING STAFF MEMBERS OF RERFGOI ARE REQUESTED TO KINDLY PARTICIPATE IN THE CLEAN INDIA CAMPAIGN EVENT ON 22/03/2023.

TIMING OF THE EVENT: 11: 00 AM ONWARDS

Google form link of participating student's :-

<https://docs.google.com/forms/d/1JbSBMMHrgevktYvZ3kwT7IFFxAsXmAfVtrWH4PFLvoI/edit>

SIGNATURE OF PROGRAM OFFICER

Principal
Regent Education & Research Foundation
Bara Kanthalia, P.O -Sewli Telinipara
Barrackpore, Kolkata- 700121

Campus : Regent Education & Research Foundation Group of Institutions

E-mail : rerfkolkata@gmail.com, Website : www.rerf.in

Campus Address:

Bara Kanthalia, Barrackpore
P.O: Sewli Telinipara, P.S.: Titagarh
Kolkata - 700 121
Tel.: 033-3008-5442/432/431, Fax: 033-3008-5442

Regd. Office Address:

11/3, Biresh Guha Street
7th Floor, Kolkata - 700 017
Tel.: 033-3221-3013



REGENT EDUCATION & RESEARCH FOUNDATION GROUP OF INSTITUTIONS

राष्ट्रीय सेवा योजना
National Service Scheme
युवा कार्यक्रम और खेल मंत्रालय
Ministry of Youth Affairs and Sports
भारत सरकार
Government of India

**TREE PLANTATION AND
CLEAN INDIA CELEBRATION
22nd MARCH, 2023
(11.00AM)**

Organized By

**REGENT EDUCATION & RESEARCH FOUNDATION
GROUP OF INSTITUTIONS,
BARRACKPORE, KOL-121**

Principal
Regent Education & Research Foundation
Bara Kanthalia, P.O. - Sewli Telinipara
Barrackpore, Kolkata - 700121

Campus : Regent Education & Research Foundation Group of Institutions

E-mail : rerfkolkata@gmail.com, Website : www.rerf.in

Campus Address:

Bara Kanthalia, Barrackpore
P.O: Sewli Telinipara, P.S.: Titagarh
Kolkata - 700 121
Tel.: 033-3008-5442/432/431, Fax: 033-3008-5442

Regd. Office Address:

11/3, Biresh Guha Street
7th Floor, Kolkata - 700 017
Tel.: 033-3221-3013



REGENT EDUCATION & RESEARCH FOUNDATION GROUP OF INSTITUTIONS

Title of the Practice: CLEAN INDIA

Objectives of the practice:

A clean India would be the best tribute India could pay to Mahatma Gandhi on his 150 birth anniversary in 2019,” said Shri Narendra Modi as he launched the Swachh Bharat Mission at Rajpath in New Delhi. On 2nd October 2014, Swachh Bharat Mission was launched throughout length and breadth of the country as a national movement. The campaign aims to achieve the vision of a ‘Clean India’ by 2nd October 2019.

The Context

A clean India would be the best tribute India could pay to Mahatma Gandhi on his 150 birth anniversary in 2019,” said Shri Narendra Modi as he launched the Swachh Bharat Mission at Rajpath in New Delhi. On 2nd October 2014, Swachh Bharat Mission was launched throughout length and breadth of the country as a national movement. The campaign aims to achieve the vision of a ‘Clean India’ by 2nd October 2019. This year, NSS Cell of RERFGOI in association with IQAC cell of RERF organized this event on 22nd March,2023. Around 50 students participated in this event.

The Practice:

“Cleanliness is next to Godliness.” To contribute in swachh bharat abhiyan activity& undertake cleanliness drive. It is everybody’s responsibility and one should keep themselves and their surroundings clean and hygienic. It also brings good and positive thoughts in the mind which slows down the occurrence of diseases. It is the mantra of Mahatma Gandhiji, Father of Nation. He demonstrated, propagated and insisted for individual and community cleanliness throughout his life. Following his footprints, Swachh bharat Mission campaign achieved encouraging results. This vision will be translated into action by bringing in community participation for clean toilets and integrated waste management to make our place open defecation free, zero waste, dust free, plastic free and green. This year, NSS Cell of RERFGOI in association with IQAC cell of RERF organized this event on 22nd March,2023.. Students have encouraged community people to join in Swachhta activity. They have participated in shramdan activity and shown their willingness and interest to keep surrounding clean.

Evidence of Success:

The Swachh Bharat Abhiyan is the most significant cleanliness campaign by the Government of India. Its responsibility of the entire citizens to keep their surrounding clean community people were encouraged to maintain their surrounding clean. Thus the students of our college have initiated one steps towards-

(Handwritten signature)
Principal
Regent Education & Research Foundation
Bara Kanthalia, P.O. - Sewli Telinipara
Barrackpore, Kolkata - 700121

Campus : Regent Education & Research Foundation Group of Institutions

E-mail : rerfkolkata@gmail.com, Website : www.rerf.in

Campus Address:

Bara Kanthalia, Barrackpore
P.O: Sewli Telinipara, P.S.: Titagarh
Kolkata - 700 121
Tel.: 033-3008-5442/432/431, Fax: 033-3008-5442

Regd. Office Address:

11/3, Biresh Guha Street
7th Floor, Kolkata - 700 017
Tel.: 033-3221-3013



REGENT EDUCATION & RESEARCH FOUNDATION GROUP OF INSTITUTIONS

cleanliness". Around 50 students participated in this event. NSS Cell of RERFGOI in association with IQAC cell of RERF organized this event on 22nd March, 2023.. Students have encouraged community people to join in Swachhta Activity. They have participated in shramdan activity and shown their willingness and interest to keep surrounding clean.

Problems encountered and resources required:

- A major hurdle in the way is the scarcity of water. Public toilets in metropolitan cities have been reported to have no water supply at all.
- Non-availability of water in many parts of rural India makes people avoid a household or a public toilet and opt for open defecation instead.

Problems encountered:

1. Dust and dirt. Various kinds of trash. In places as huge as stadiums and airports, it's a must to have rubbish bins in every corner.
2. Toilets.
3. Thousands of seats.
4. Floors.

Resources required:-

Swachh Bharat Abhiyan is a five year long cleanliness campaign launched by the Government of India on 2nd October 2014. The campaign was aimed for making the streets, roads and offices clean from filth and garbage. One of the main objectives of the drive is to make India Open Defecation Free (ODF). The campaign also targets raising public awareness about cleanliness through rigorous media campaigns and to institute door to door garbage collection in rural/urban household and ensuring its safe disposal

Make the most of the day by working on things that don't get done often, like cleaning the chairs in the auditorium or dusting the tops of lockers. If you like, you could ask for permission to plant some flowers around campus, like in a flower bed near the school's entrance.

Principal
Regent Education & Research Foundation
Bara Kanthalia, P.O. -Sewli Telinipara
Barrackpore, Kolkata- 700121

Campus : Regent Education & Research Foundation Group of Institutions

E-mail : rerfkolkata@gmail.com, Website : www.rerf.in

Campus Address:

Bara Kanthalia, Barrackpore
P.O: Sewli Telinipara, P.S.: Titagarh
Kolkata - 700 121
Tel.: 033-3008-5442/432/431, Fax: 033-3008-5442

Regd. Office Address:

11/3, Biresh Guha Street
7th Floor, Kolkata - 700 017
Tel.: 033-3221-3013



REGENT EDUCATION & RESEARCH FOUNDATION GROUP OF INSTITUTIONS

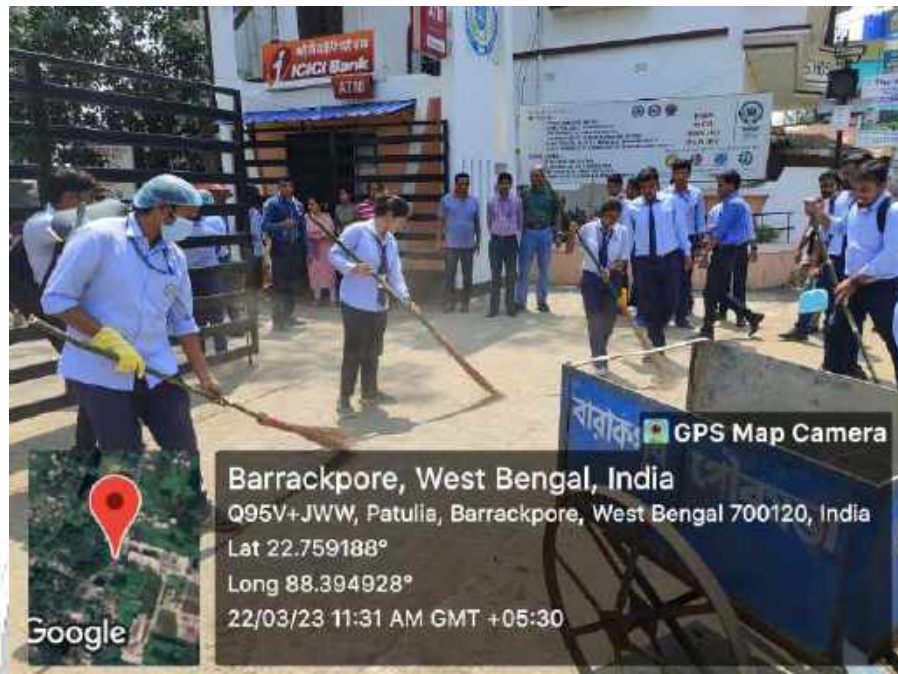

Campus : Regent Education & Research Foundation Group of Institutions

E-mail : rerfkolkata@gmail.com, Website : www.rerf.in

Campus Address:

Bara Kanthalia, Barrackpore
P.O: Sewli Telinipara, P.S.: Titagarh
Kolkata - 700 121
Tel.: 033-3008-5442/432/431, Fax: 033-3008-5442

Regd. Office Address:

11/3, Biresh Guha Street
7th Floor, Kolkata - 700 017
Tel.: 033-3221-3013



REGENT EDUCATION & RESEARCH FOUNDATION GROUP OF INSTITUTIONS



CERTIFICATE OF PARTICIPATION TREE PLANTATION AND CLEAN INDIA CELEBRATION

Organized By
NATIONAL SERVICE SCHEME (NSS)
Regent Education & Research Foundation Group of Institution, Barrackpore, Kol-121
ON 22nd March, 2023

This is to certify that

PARTICIPATED IN TREE PLANTATION AND CLEAN INDIA CELEBRATION IN RERFGOI UNDER
NSS CELL, RERF 22.03.2023

MR. PRABAL KUMAR BASAK
CONVENER, IIC, RERFGI

DR. RAJARSHI BANDYOPADHAYA
PRINCIPAL, RERFGI

Principal
Regent Education & Research Foundation
Bara Kanthalia, P.O - Sewli Telinipara
Barrackpore, Kolkata- 700121

Campus : Regent Education & Research Foundation Group of Institutions

E-mail : rerfkolkata@gmail.com, Website : www.rerf.in

Campus Address:

Bara Kanthalia, Barrackpore
P.O: Sewli Telinipara, P.S.: Titagarh
Kolkata - 700 121
Tel.: 033-3008-5442/432/431, Fax: 033-3008-5442

Regd. Office Address:

11/3, Biresh Guha Street
7th Floor, Kolkata - 700 017
Tel.: 033-3221-3013



REGENT EDUCATION & RESEARCH FOUNDATION GROUP OF INSTITUTIONS



NSS Cell
**Maulana Abul Kalam Azad University of
Technology, West Bengal**



NOTICE

DATE 14/01/2023

THIS IS FOR THE INFORMATION OF ALL THAT NSS CELL OF RERF IS GOING TO ORGANISE THE ONLINE QUIZ ON YOUTH WEEK ON 19/01/2023 IN ONLINE MODE TO CELEBRATE NATIONAL YOUTH WEEK.

THEREFORE, ALL STUDENTS, TEACHING AND NON-TEACHING STAFF MEMBERS OF RERFGOI ARE REQUESTED TO KINDLY PARTICIPATE IN THE EVENT ON 19/01/2023 IN ONLINE MODE

THE ONLINE EVENT WILL BE HELD IN THE FOLLOWING LINK
<https://forms.gle/aoZEdxgJe7TQ8Fo88>

TIMING OF THE EVENT: 03:00 PM ONWARDS



SIGNATURE OF PROGRAM OFFICER

Campus : Regent Education & Research Foundation Group of Institutions

E-mail : rerfkolkata@gmail.com, Website : www.rerf.in

Campus Address:

Bara Kanthalia, Barrackpore
P.O: Sewli Telinipara, P.S.: Titagarh
Kolkata - 700 121
Tel.: 033-3008-5442/432/431, Fax: 033-3008-5442

Regd. Office Address:

11/3, Biresh Guha Street
7th Floor, Kolkata - 700 017
Tel.: 033-3221-3013



REGENT EDUCATION & RESEARCH FOUNDATION GROUP OF INSTITUTIONS



राष्ट्रीय सेवा योजना
National Service Scheme
युवा कार्यक्रम और खेल मंत्रालय
Ministry of Youth Affairs and Sports
भारत सरकार
Government of India

QUIZ ON YOUTH WEEK (AZADI KA AMRIT MAHOTSAV) ON 19TH JAN 2023 (3.00PM)

CELEBRATION OF YOUTH WEEK 2023 THROUGH ONLINE QUIZ

Organized By

REGENT EDUCATION & RESEARCH FOUNDATION GROUP OF INSTITUTIONS,
BARRACKPORE, KOL-121

Mr. PRABAL KUMAR BASAK
EE DEPARTMENT
CONVENER, NSS COMMITTEE,
RERFOCI

Last Date of Registration; 18.01.2023
E-Certificate will provide by Email

CLICK HERE
TO REGISTER



Campus : Regent Education & Research Foundation Group of Institutions

E-mail : rerfokolkata@gmail.com, Website : www.rerf.in

Campus Address:

Bara Kanthalia, Barrackpore
P.O: Sewli Telinipara, P.S.: Titagarh
Kolkata - 700 121
Tel.: 033-3008-5442/432/431, Fax: 033-3008-5442

Regd. Office Address:

11/3, Biresh Guha Street
7th Floor, Kolkata - 700 017
Tel.: 033-3221-3013



REGENT EDUCATION & RESEARCH FOUNDATION GROUP OF INSTITUTIONS

Title of the Practice: Online Quiz on Youth Week (Azadi ka Amrit Mahotsav)

The Online Quiz on Youth Week (Azadi ka Amrit Mahotsav) was organized on 19th January 2023 by Regent Education & Research Foundation Group of Institutions, Barrackpore, Kolkata-121. The event aimed to commemorate the glorious 75 years of India's independence and observe the Youth Week as per the NSS Manual (2006). The online quiz provided a platform for participants to showcase their knowledge about India's freedom struggle, national heritage, and the contributions of notable personalities.

Objectives of the practice:

The objectives of conducting the Online Quiz on Youth Week were as follows:

- To celebrate and commemorate the 75th anniversary of India's independence, known as Azadi ka Amrit Mahotsav.
- To engage and involve the youth in activities that promote awareness and understanding of India's freedom struggle.
- To encourage participants to enhance their knowledge about India's history, culture, and national heroes.
- To provide a platform for participants to showcase their knowledge and compete in a healthy and competitive environment.
- To foster a sense of national pride and patriotism among the participants.

The Context

The Online Quiz on Youth Week was organized in response to the nationwide celebration of Azadi ka Amrit Mahotsav, marking the 75th anniversary of India's independence. As per the NSS Manual (2006), the Youth Week was observed from 12th to 19th January 2023. The Regent Education & Research Foundation Group of Institutions, Barrackpore, Kolkata-121, took the initiative to organize the quiz competition as part of the week-long celebrations. The event aimed to engage the youth and promote their knowledge about India's rich cultural heritage, freedom fighters, and the life of Swami Vivekananda.

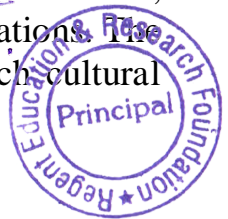

Campus : Regent Education & Research Foundation Group of Institutions

E-mail : rerfkolkata@gmail.com, Website : www.rerf.in

Campus Address:

Bara Kanthalia, Barrackpore
P.O: Sewli Telinipara, P.S.: Titagarh
Kolkata - 700 121
Tel.: 033-3008-5442/432/431, Fax: 033-3008-5442

Regd. Office Address:

11/3, Biresh Guha Street
7th Floor, Kolkata - 700 017
Tel.: 033-3221-3013



REGENT EDUCATION & RESEARCH FOUNDATION GROUP OF INSTITUTIONS

The Practice:

The Online Quiz on Youth Week witnessed the participation of 90 individuals from various locations. The quiz competition was conducted in an online format, utilizing a suitable platform for hosting the event. The quiz questions were designed to test participants' knowledge about India's freedom struggle, historical events, national heroes, and significant achievements. The participants were given a specific time frame to answer the questions, and the scores were calculated based on accuracy and speed. The quiz was conducted in a fair and transparent manner, ensuring equal opportunities for all participants.

Evidence of Success:

The success of the Online Quiz on Youth Week can be measured by the active participation of 90 individuals from different locations. The quiz competition provided an opportunity for participants to showcase their knowledge and compete with their peers. The event received positive feedback, with participants expressing their satisfaction with the quiz format and the quality of questions. The success of the quiz competition demonstrated the enthusiasm and interest of the youth in learning about India's history and heritage.

Problems encountered and resources required:

During the organization of the online quiz, technical issues such as internet connectivity problems or audio/video disruptions may have been encountered. However, proactive measures were taken to minimize such disruptions, ensuring a smooth and uninterrupted quiz experience. Adequate resources, including a stable internet connection, a suitable online platform for hosting the quiz, and a robust system for recording and evaluating participants' responses, were required to facilitate the success of the event.

Conclusion:

The Online Quiz on Youth Week (Azadi ka Amrit Mahotsav) organized by Regent Education & Research Foundation Group of Institutions, Barrackpore, Kolkata-121, provided a platform for participants to showcase their knowledge about India's freedom struggle and cultural heritage. The event successfully engaged the youth in activities that

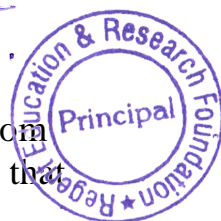

Campus : Regent Education & Research Foundation Group of Institutions

E-mail : rerfkolkata@gmail.com, Website : www.rerf.in

Campus Address:

Bara Kanthalia, Barrackpore
P.O: Sewli Telinipara, P.S.: Titagarh
Kolkata - 700 121
Tel.: 033-3008-5442/432/431, Fax: 033-3008-5442

Regd. Office Address:

11/3, Biresh Guha Street
7th Floor, Kolkata - 700 017
Tel.: 033-3221-3013



REGENT EDUCATION & RESEARCH FOUNDATION GROUP OF INSTITUTIONS

promoted a deeper understanding and appreciation of India's history.

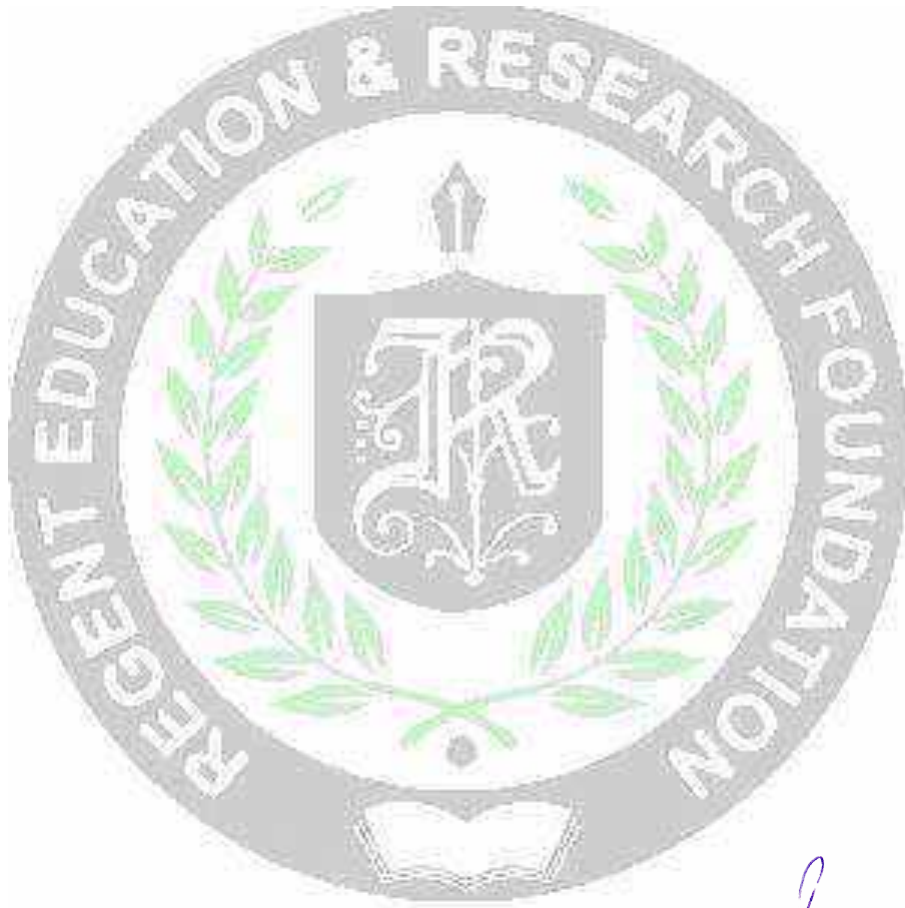

Campus : Regent Education & Research Foundation Group of Institutions

E-mail : refkolkata@gmail.com, Website : www.ref.in

Campus Address:

Bara Kanthalia, Barrackpore
P.O: Sewli Telinipara, P.S.: Titagarh
Kolkata - 700 121
Tel.: 033-3008-5442/432/431, Fax: 033-3008-5442

Regd. Office Address:

11/3, Biresh Guha Street
7th Floor, Kolkata - 700 017
Tel.: 033-3221-3013



REGENT EDUCATION & RESEARCH FOUNDATION GROUP OF INSTITUTIONS



NSS Cell
**Maulana Abul Kalam Azad University of
Technology, West Bengal**



NOTICE

DATE 29/07/2022

THIS IS FOR THE INFORMATION OF ALL THAT NSS CELL OF RERF IS GOING TO ORGANISE DIGITAL POSTER MAKING TO CELEBRATE AND CREATE AWARENESS ON AZADI KA AMRIT MAHOTSAV- HAR GHAR TIRANGA .THE OBJECTIVE OF THIS PROGRAM IS TO INFORM PEOPLE ABOUT THE IMPORTANCE OF NATIONAL FLAG HOISTING ON 15/08/2022 .

THEREFORE, ALL STUDENTS, TEACHING AND NON-TEACHING STAFF MEMBERS OF RERFGOI ARE REQUESTED TO KINDLY PARTICIPATE IN THE DIGITAL POSTER MAKING EVENT AND SUBMIT IT THROUGH THE GIVEN GOOGLE FORM WITHIN 12/08/2022 MAINTAINING THE GIVEN FORMAT.

https://docs.google.com/forms/d/e/1FAIpQLScjb7KaNy7sqCRznoPLTBf3AoxLe5dHk4hkSec0II30fWwLHw/viewform?usp=pp_url

SIGNATURE OF PROGRAM OFFICER



Campus : Regent Education & Research Foundation Group of Institutions

E-mail : rerfkolkata@gmail.com, Website : www.rerf.in

Campus Address:

Bara Kanthalia, Barrackpore
P.O: Sewli Telinipara, P.S.: Titagarh
Kolkata - 700 121
Tel.: 033-3008-5442/432/431, Fax: 033-3008-5442

Regd. Office Address:

11/3, Biresh Guha Street
7th Floor, Kolkata - 700 017
Tel.: 033-3221-3013



REGENT EDUCATION & RESEARCH FOUNDATION GROUP OF INSTITUTIONS

Title of the Practice: "Har Ghar Tiranga" Campaign (Azadi ka Amrit Mahotsav)

"Har Ghar Tiranga" is a campaign initiated under the aegis of Azadi Ka Amrit Mahotsav to encourage individuals to bring the Tiranga (Indian National Flag) home and hoist it, marking the 75th year of India's independence. The campaign aims to foster a personal connection with the national flag and symbolize the collective commitment to nation-building. It intends to invoke patriotism and promote awareness about the significance of the Indian National Flag. The NSS Cell of RERFGOI organized this event on 15th August 2022, where flag hoisting was practiced, and approximately 50 students participated.

Objectives of the practice:

The objectives of the "Har Ghar Tiranga" campaign are as follows:

- Encourage individuals to bring the Tiranga home and hoist it with pride.
- Establish a personal connection with the national flag and promote a sense of patriotism.
- Generate awareness about the history, significance, and protocol associated with the Indian National Flag.
- Instill a sense of responsibility and commitment to nation-building among the participants.
- Celebrate the 75th year of India's independence by involving citizens in a symbolic act of displaying the national flag at their homes.

The Context:

The "Har Ghar Tiranga" campaign was launched as part of the nationwide celebration of Azadi ka Amrit Mahotsav, marking the 75th anniversary of India's independence. The Ministry of Youth Affairs & Sports initiated the event with the objective of inspiring Indians across the country to hoist or display the national flag at their workplaces and homes. The campaign aimed to invoke feelings of patriotism and foster a deeper connection with the Indian National Flag.

The Practice:

The "Har Ghar Tiranga" event organized by the NSS Cell of RERFGOI on 15th August 2022 witnessed the participation of approximately 50 students. The program included flag hoisting, where participants had the opportunity to practice the correct protocols associated with hoisting the national flag. The event was inaugurated by Dr. Rajorshi Bandopadhyay (Principal, RERF) and Mr. Subhankar Ghosh (Registrar, RERF), who emphasized the importance of the campaign and its significance in strengthening the bond between citizens and the national flag.

Evidence of Success:

Campus : Regent Education & Research Foundation Group of Institutions

E-mail : rerfkolkata@gmail.com, Website : www.rerf.in

Campus Address:

**Bara Kanthalia, Barrackpore
P.O: Sewli Telinipara, P.S.: Titagarh
Kolkata - 700 121
Tel.: 033-3008-5442/432/431, Fax: 033-3008-5442**

Regd. Office Address:

**11/3, Biresh Guha Street
7th Floor, Kolkata - 700 017
Tel.: 033-3221-3013**

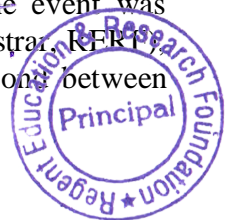



REGENT EDUCATION & RESEARCH FOUNDATION GROUP OF INSTITUTIONS

The success of the "Har Ghar Tiranga" campaign can be measured by the active participation of approximately 50 students in the event. The campaign effectively created awareness and instilled a sense of patriotism among the participants. The act of hoisting the national flag at their homes served as a symbol of personal connection and commitment to nation-building. The event received positive feedback from the participants, who expressed their gratitude for the opportunity to engage in such a meaningful activity.

Problems encountered and resources required:

During the organization of the "Har Ghar Tiranga" event, logistical challenges such as arranging the flag hoisting ceremony and ensuring the availability of appropriate flags may have been encountered. However, the NSS Cell of RERFGOI proactively managed these challenges by procuring the necessary resources and coordinating the event effectively. Resources required for the event included the Indian National Flag, flagpoles, suitable locations for flag hoisting, and the presence of knowledgeable individuals to guide participants regarding flag protocols.

Conclusion:

The "Har Ghar Tiranga" campaign organized by the NSS Cell of RERFGOI successfully engaged students in practicing flag hoisting and promoting a sense of patriotism among participants. The campaign's objective of fostering a personal connection with the Indian National Flag and invoking.



Campus : Regent Education & Research Foundation Group of Institutions

E-mail : rerfkolkata@gmail.com, Website : www.rerf.in

Campus Address:

Bara Kanthalia, Barrackpore
P.O: Sewli Telinipara, P.S.: Titagarh
Kolkata - 700 121
Tel.: 033-3008-5442/432/431, Fax: 033-3008-5442

Regd. Office Address:

11/3, Biresh Guha Street
7th Floor, Kolkata - 700 017
Tel.: 033-3221-3013



REGENT EDUCATION & RESEARCH FOUNDATION GROUP OF INSTITUTIONS



Campus : Regent Education & Research Foundation Group of Institutions

E-mail : rerfkolkata@gmail.com, Website : www.rerf.in

Campus Address:

**Bara Kanthalia, Barrackpore
P.O: Sewli Telinipara, P.S.: Titagarh
Kolkata - 700 121
Tel.: 033-3008-5442/432/431, Fax: 033-3008-5442**

Regd. Office Address:

**11/3, Biresh Guha Street
7th Floor, Kolkata - 700 017
Tel.: 033-3221-3013**



REGENT EDUCATION & RESEARCH FOUNDATION GROUP OF INSTITUTIONS



NSS Cell
Maulana Abul Kalam Azad University of
Technology, West Bengal



Report on NSS activities

NOTICE

DATE 14/06/2022

THIS IS FOR THE INFORMATION OF ALL THAT NSS CELL OF RERF IS GOING TO ORGANISE INTERNATIONAL YOGA DAY ON 21/06/2022 AT 11:00 AM THROUGH ONLINE MODE. THE OBJECTIVE OF THIS PROGRAM IS TO STAY FIT AND HEALTHY.

THEREFORE, ALL STUDENTS, TEACHING AND NON-TEACHING STAFF MEMBERS OF RERFGOI ARE REQUESTED TO KINDLY PARTICIPATE IN THE 'INTERNATIONAL YOGA DAY PROGRAM ON 21/06/2022 AT 11:00 AM THROUGH ONLINE MODE.

THE ONLINE EVENT WILL BE HELD IN THE FOLLOWING LINK

meet.google.com/fep-jxwp-jyb

SIGNATURE PROGRAM OFFICER

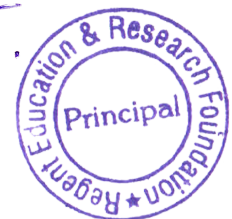

Campus : Regent Education & Research Foundation Group of Institutions

E-mail : rerfolkata@gmail.com, Website : www.rerf.in

Campus Address:

Bara Kanthalia, Barrackpore
P.O: Sewli Telinipara, P.S.: Titagarh
Kolkata - 700 121
Tel.: 033-3008-5442/432/431, Fax: 033-3008-5442

Regd. Office Address:

11/3, Biresh Guha Street
7th Floor, Kolkata - 700 017
Tel.: 033-3221-3013



REGENT EDUCATION & RESEARCH FOUNDATION GROUP OF INSTITUTIONS

Title of the Practice: International Yoga Day

International Yoga Day is celebrated worldwide on 21st June every year to promote the importance of yoga in maintaining a healthy body and mind. Yoga is an ancient practice that originated in India and has gained global recognition for its numerous physical and mental benefits. The event aims to raise awareness about the transformative power of yoga and encourage people to incorporate it into their daily lives.

Objectives of the practice:

The objectives of celebrating International Yoga Day are as follows:

- To spread awareness about the physical, mental, and spiritual benefits of practicing yoga.
- To encourage individuals to adopt a healthy lifestyle through the regular practice of yoga.
- To promote global peace, harmony, and unity through the practice of yoga.
- To emphasize the importance of maintaining overall well-being and inner peace.
- To highlight the contribution of yoga in achieving a balanced and sustainable development.

The Context:

On 21st June 2022, International Yoga Day was celebrated online, bringing together 90 participants from various locations. The event aimed to provide a platform for individuals to engage in yoga practices and learn from esteemed yoga expert Tanumoy Das. Tanumoy Das is a highly accomplished yoga practitioner and has received prestigious awards like the Yoga Ratnamani Award and the Yoga Ratna Award. He has also achieved the title of All India Yoga Champion and serves as a yoga judge at the district and state levels. Tanumoy Das is associated with the Krishnagar Swami Vivekananda Yoga Centre and is affiliated with organizations such as the Nadia District Body Building & Yoga Culture Association, Sarabharatiya Sangeet-o-Sanskriti Parishad, and the Indian Yoga Association.

The Practice:

The online celebration of International Yoga Day provided participants with the opportunity to engage in various yoga practices led by Tanumoy Das. The session included a combination of asanas (physical postures), pranayama (breathing exercises), and meditation techniques. Tanumoy Das shared his expertise, guiding participants through the practices and emphasizing the correct alignment, breathing techniques, and mindfulness. The session aimed to create a serene and inclusive environment where individuals could experience the holistic benefits of yoga and deepen their understanding of its principles.

Evidence of Success:

The success of the online International Yoga Day celebration can be measured through the active participation of 88 individuals from different locations. The positive feedback received from the participants

Campus : Regent Education & Research Foundation Group of Institutions

E-mail : rerfkolkata@gmail.com, Website : www.rerf.in

Campus Address:

**Bara Kanthalia, Barrackpore
P.O: Sewli Telinipara, P.S.: Titagarh
Kolkata - 700 121
Tel.: 033-3008-5442/432/431, Fax: 033-3008-5442**

Regd. Office Address:

**11/3, Biresh Guha Street
7th Floor, Kolkata - 700 017
Tel.: 033-3221-3013**

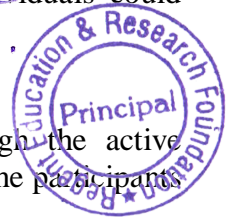



REGENT EDUCATION & RESEARCH FOUNDATION GROUP OF INSTITUTIONS

reflects their satisfaction and the value they derived from the session. Participants expressed their gratitude for the opportunity to learn from Tanumoy Das and appreciated his expertise in guiding them through the yoga practices. The event successfully fulfilled its objective of promoting the benefits of yoga and inspiring individuals to incorporate it into their daily lives.

Problems encountered and resources required:

Despite the online format, technical issues such as internet connectivity problems or audio/video disruptions could have been encountered during the event. However, proactive measures were taken to ensure smooth communication and minimize disruptions. Adequate resources such as a stable internet connection, audiovisual equipment, and a suitable platform for hosting the online session were required to facilitate the event's success.

Conclusion:

The celebration of International Yoga Day on 21st June 2023 provided a platform for individuals to engage in yoga practices and learn from the expertise of Tanumoy Das, an acclaimed yoga practitioner. The online event witnessed active participation from 88 individuals, promoting the physical, mental, and spiritual benefits of yoga. The success of the event demonstrated the positive impact of yoga on overall well-being and highlighted the importance of incorporating it into our daily lives. International Yoga Day continues to inspire individuals worldwide to embrace the transformative power of yoga for a healthier and more balanced life.



Campus : Regent Education & Research Foundation Group of Institutions

E-mail : refkolkata@gmail.com, Website : www.ref.in

Campus Address:

Bara Kanthalia, Barrackpore
P.O: Sewli Telinipara, P.S.: Titagarh
Kolkata - 700 121
Tel.: 033-3008-5442/432/431, Fax: 033-3008-5442

Regd. Office Address:

11/3, Biresh Guha Street
7th Floor, Kolkata - 700 017
Tel.: 033-3221-3013



REGENT EDUCATION & RESEARCH FOUNDATION GROUP OF INSTITUTIONS



Principal

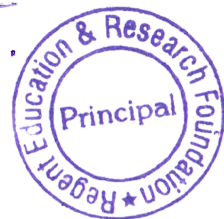

Campus : Regent Education & Research Foundation Group of Institutions

E-mail : rerfkolkata@gmail.com, Website : www.rerf.in

Campus Address:

Bara Kanthalia, Barrackpore
P.O: Sewli Telinipara, P.S.: Titagarh
Kolkata - 700 121
Tel.: 033-3008-5442/432/431, Fax: 033-3008-5442

Regd. Office Address:

11/3, Biresh Guha Street
7th Floor, Kolkata - 700 017
Tel.: 033-3221-3013



REGENT EDUCATION & RESEARCH FOUNDATION GROUP OF INSTITUTIONS



NSS Cell
**Maulana Abul Kalam Azad University of
Technology, West Bengal**



Report on NSS activities

NOTICE

DATE 17/06/2023

THIS IS FOR THE INFORMATION OF ALL THAT NSS CELL OF RERF IS GOING TO ORGANISE INTERNATIONAL YOGA DAY ON 21/06/2023 AT 12:30 PM THROUGH ONLINE MODE. THE OBJECTIVE OF THIS PROGRAM IS TO STAY FIT AND HEALTHY.

THEREFORE, ALL STUDENTS, TEACHING AND NON-TEACHING STAFF MEMBERS OF RERFGOI ARE REQUESTED TO KINDLY PARTICIPATE IN THE 'INTERNATIONAL YOGA DAY PROGRAM ON 21/06/2023 AT 12:30 PM THROUGH ONLINE MODE.

SIGNATURE OF PROGRAM OFFICER

Principal
Regent Education & Research Foundation
Bara Kanthalia, P.O - Sewli Telinipara
Barrackpore, Kolkata- 700121

Campus : Regent Education & Research Foundation Group of Institutions

E-mail : rerfkolkata@gmail.com, Website : www.rerf.in

Campus Address:

Bara Kanthalia, Barrackpore
P.O: Sewli Telinipara, P.S.: Titagarh
Kolkata - 700 121
Tel.: 033-3008-5442/432/431, Fax: 033-3008-5442

Regd. Office Address:

11/3, Biresh Guha Street
7th Floor, Kolkata - 700 017
Tel.: 033-3221-3013



REGENT EDUCATION & RESEARCH FOUNDATION GROUP OF INSTITUTIONS

Title of the Practice: International Yoga Day

International Yoga Day is celebrated worldwide on 21st June every year to promote the importance of yoga in maintaining a healthy body and mind. Yoga is an ancient practice that originated in India and has gained global recognition for its numerous physical and mental benefits. The event aims to raise awareness about the transformative power of yoga and encourage people to incorporate it into their daily lives.

Objectives of the practice:

The objectives of celebrating International Yoga Day are as follows:

- To spread awareness about the physical, mental, and spiritual benefits of practicing yoga.
- To encourage individuals to adopt a healthy lifestyle through the regular practice of yoga.
- To promote global peace, harmony, and unity through the practice of yoga.
- To emphasize the importance of maintaining overall well-being and inner peace.
- To highlight the contribution of yoga in achieving a balanced and sustainable development.

The Context:

On 21st June 2023, International Yoga Day was celebrated online, bringing together 88 participants from various locations. The event aimed to provide a platform for individuals to engage in yoga practices and learn from esteemed yoga expert Tanumoy Das. Tanumoy Das is a highly accomplished yoga practitioner and has received prestigious awards like the Yoga Ratnamani Award and the Yoga Ratna Award. He has also achieved the title of All India Yoga Champion and serves as a yoga judge at the district and state levels. Tanumoy Das is associated with the Krishnagar Swami Vivekananda Yoga Centre and is affiliated with organizations such as the Nadia District Body Building & Yoga Culture Association, Sarabharatiya Sangeet-o-Sanskriti Parishad, and the Indian Yoga Association.

The Practice:

The online celebration of International Yoga Day provided participants with the opportunity to engage in various yoga practices led by Tanumoy Das. The session included a combination of asanas (physical postures), pranayama (breathing exercises), and meditation techniques. Tanumoy Das shared his expertise, guiding participants through the practices and emphasizing the correct alignment, breathing techniques, and mindfulness. The session aimed to create a serene and inclusive environment where individuals could experience the holistic benefits of yoga and deepen their understanding of its principles.

Evidence of Success:

The success of the online International Yoga Day celebration can be measured through the active

Campus : Regent Education & Research Foundation Group of Institutions

E-mail : rerfkolkata@gmail.com, Website : www.rerf.in

Campus Address:

**Bara Kanthalia, Barrackpore
P.O: Sewli Telinipara, P.S.: Titagarh
Kolkata - 700 121
Tel.: 033-3008-5442/432/431, Fax: 033-3008-5442**

Regd. Office Address:

**11/3, Biresh Guha Street
7th Floor, Kolkata - 700 017
Tel.: 033-3221-3013**



REGENT EDUCATION & RESEARCH FOUNDATION GROUP OF INSTITUTIONS

participation of 88 individuals from different locations. The positive feedback received from the participants reflects their satisfaction and the value they derived from the session. Participants expressed their gratitude for the opportunity to learn from Tanumoy Das and appreciated his expertise in guiding them through the yoga practices. The event successfully fulfilled its objective of promoting the benefits of yoga and inspiring individuals to incorporate it into their daily lives.

Problems encountered and resources required:

Despite the online format, technical issues such as internet connectivity problems or audio/video disruptions could have been encountered during the event. However, proactive measures were taken to ensure smooth communication and minimize disruptions. Adequate resources such as a stable internet connection, audiovisual equipment, and a suitable platform for hosting the online session were required to facilitate the event's success.

Conclusion:

The celebration of International Yoga Day on 21st June 2023 provided a platform for individuals to engage in yoga practices and learn from the expertise of Tanumoy Das, an acclaimed yoga practitioner. The online event witnessed active participation from 88 individuals, promoting the physical, mental, and spiritual benefits of yoga. The success of the event demonstrated the positive impact of yoga on overall well-being and highlighted the importance of incorporating it into our daily lives. International Yoga Day continues to inspire individuals worldwide to embrace the transformative power of yoga for a healthier and more balanced life.

Principal
Regent Education & Research Foundation
Bara Kanthalia, P.O - Sewli Telinipara
Barrackpore, Kolkata- 700121

Campus : Regent Education & Research Foundation Group of Institutions

E-mail : refkolkata@gmail.com, Website : www.ref.in

Campus Address:

Bara Kanthalia, Barrackpore
P.O: Sewli Telinipara, P.S.: Titagarh
Kolkata - 700 121
Tel.: 033-3008-5442/432/431, Fax: 033-3008-5442

Regd. Office Address:

11/3, Biresh Guha Street
7th Floor, Kolkata - 700 017
Tel.: 033-3221-3013



REGENT EDUCATION & RESEARCH FOUNDATION GROUP OF INSTITUTIONS

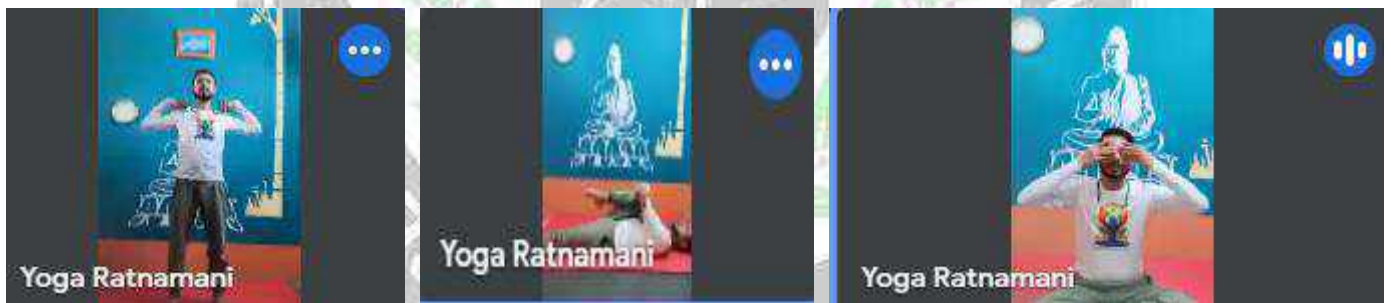
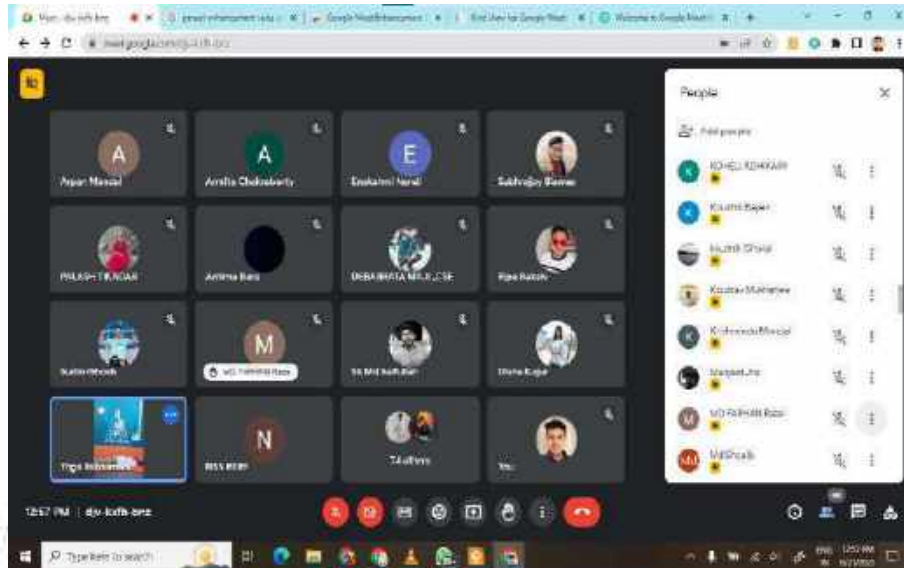

Principal
Regent Education & Research Foundation
Bara Kanthalia, P.O - Sewli Telinipara
Barrackpore, Kolkata- 700121

Campus : Regent Education & Research Foundation Group of Institutions

E-mail : rerfkolkata@gmail.com, Website : www.rerf.in

Campus Address:

Bara Kanthalia, Barrackpore

P.O: Sewli Telinipara, P.S.: Titagarh

Kolkata - 700 121

Tel.: 033-3008-5442/432/431, Fax: 033-3008-5442

Regd. Office Address:

11/3, Biresh Guha Street

7th Floor, Kolkata - 700 017

Tel.: 033-3221-3013



REGENT EDUCATION & RESEARCH FOUNDATION GROUP OF INSTITUTIONS



The certificate features a central illustration of a person in a yoga pose, surrounded by colorful leaves. The text is centered and includes the names of the organizers and the date of the event.

**CERTIFICATE
OF PARTICIPATION**
THIS CERTIFICATE IS PROUDLY
PRESENTED TO :

**For His Participation in Online
YOGA PRACTICE SESSION ON INTERNATIONAL DAY OF YOGA ON 21ST JUNE 2023**

Organized By
**REGENT EDUCATION & RESEARCH FOUNDATION GROUP OF INSTITUTIONS,
BARRACKPORE, KOL-121**

Mr. PRABAL KUMAR BASAK
CONVENER, NSS COMMITTEE, REFQDI

Mr. Subhankar Ghosh
REGISTRAR, REFQDI

Dr. Samik Chakraborty
PRINCIPAL, REFQDI

Campus : Regent Education & Research Foundation Group of Institutions

E-mail : refkolkata@gmail.com, Website : www.ref.in

Campus Address:

Bara Kanthalia, Barrackpore
P.O: Sewli Telinipara, P.S.: Titagarh
Kolkata - 700 121
Tel.: 033-3008-5442/432/431, Fax: 033-3008-5442

Regd. Office Address:

11/3, Biresh Guha Street
7th Floor, Kolkata - 700 017
Tel.: 033-3221-3013



REGENT EDUCATION & RESEARCH FOUNDATION GROUP OF INSTITUTIONS

SEMINAR on “Self Confidence makes you strong and beautiful from within” and Women’s Day Celebration

Internal Complaint Committee of Regent Education and Research Foundation Group of Institutions organized a one day seminar program on “**SELF CONFIDENCE MAKES YOU STRONG AND BEAUTIFUL FROM WITHIN**” along with *Women’s Day Celebration* on 17th March, 2023. The program was held in seminar hall of RERF Building in offline mode.

Program schedule

Program	Time
Inauguration Program & Felicitation of Guest	02:30 pm - 02:50 pm
Welcome Address by ICC Chairperson, Dr. Nibedita Mukherjee	02:50 pm - 03:00 pm
Welcome Address by RIST Principal, Milon Majumder	03:00 pm - 03:10 pm
Start of the Seminar	03:10 pm - 04:00 pm
Interactive Session with participants	04:00 pm – 04:30 pm
Vote of Thanks by DEAN-Academic, RERFGOI, Dr. Rajorshi Bandyopadhyay	04:30 pm – 04:40 pm
Women Day Celebration by cake cutting and photo session	04:40 pm – 05:00 pm

The inauguration program started with the lighting of the lamp and felicitation of the Guest followed by a warm welcome address was given *ICC Chairperson, Dr. Nibedita Mukherjee*. The program was hosted by Rajalakshmi Chandrasekhar, Member of ICC Cell and Assistant professor of RERFGOI. As Women’s Day 2023 theme colour was *purple* so we all lady faculties decided to wear purple outfit. Purple signifies justice, dignity and being loyal to the cause. Green symbolizes hope and white represents purity. The colours originated from the Women's Social and Political Union (WSPU) in the UK in 1908. After a good interactive session the vote of Thanks was given by DEAN-Academic, RERFGOI, Dr. Rajorshi Bandyopadhyay. The program ended with Women’s Day Celebration by cake cutting and photo session.

Number of students participated: 75

Principal
Regent Education & Research Foundation
Bara Kanthalia, P.O.-Sewli Telinipara
Barrackpore, Kolkata- 700121

Campus : Regent Education & Research Foundation Group of Institutions

E-mail : rerfkolkata@gmail.com, Website : www.rerf.in

Campus Address:

Bara Kanthalia, Barrackpore
P.O: Sewli Telinipara, P.S.: Titagarh
Kolkata - 700 121
Tel.: 033-3008-5442/432/431, Fax: 033-3008-5442

Regd. Office Address:

11/3, Biresh Guha Street
7th Floor, Kolkata - 700 017
Tel.: 033-3221-3013



REGENT EDUCATION & RESEARCH FOUNDATION GROUP OF INSTITUTIONS

Speaker Schedule

Time	Session
03:10 pm – 03:20 pm	Ms. Suchandra Gupta
03:20 pm – 03:40 pm	Mrs. Tamali Chaki
03:40 pm – 04:00 pm	Sukanta Kumar Mitra
04:00 pm – 04:30 pm	Interactive Session by all the three Guest Speakers

Speakers Present



1. Sukanta Kumar Mitra done M.Sc in Applied Psychology, LL.B (C.U) , 2 Year & Stress Management(J.U) , 1year Diploma in Conflict Management (J. U),Family Counselling Trained By STATE LEGAL SERVICE AUTHORITY(W.B) , deals with – Mental Health, Faculty of "Center for Counselling Services and Studies in Self Development (CCSSS)"(JADAVPUR UNIVERSITY) & NSOU, Psychological Counsellor of Bhairab Ganguly college, he is 22 years experienced.



2. Tamali Chaki work as a teacher in a school since 2006. I have attended numerous classes and workshops regarding mental health. Currently, I am pursuing a course under the Faculty of Center for Counselling Services and Studies in Self Development (CCSSS), Jadavpur University.



3. Suchandra Gupta is a professional Social Worker, currently working as a Project Coordinator cum Counselor in a HIV related project in Child In Need Institute (CINI) for more than two years, resource person in Nirman Foundation.

Principal

Regent Education & Research Foundation
Bara Kanthalia, P.O -Sewli Telinipara
Barrackpore, Kolkata- 700121

Campus : Regent Education & Research Foundation Group of Institutions

E-mail : rerfkolkata@gmail.com, Website : www.rerf.in

Campus Address:

Bara Kanthalia, Barrackpore
P.O: Sewli Telinipara, P.S.: Titagarh
Kolkata - 700 121
Tel.: 033-3008-5442/432/431, Fax: 033-3008-5442

Regd. Office Address:

11/3, Biresh Guha Street
7th Floor, Kolkata - 700 017
Tel.: 033-3221-3013



REGENT EDUCATION & RESEARCH FOUNDATION GROUP OF INSTITUTIONS

FLYER:

SEMINAR ON "SELF CONFIDENCE MAKES YOU STRONG AND BEAUTIFUL FROM WITHIN"

ORGANISED BY INTERNAL COMPLAINT COMMITTEE (ICC)
OF RERFGI IN ASSOCIATION WITH IQAC CELL.



SUKANTA K.R. MITRA
Psychological Counsellor
Attached with- CCSSS
(JADAVPUR UNIVERSITY)



TAMALI CHAKI
Psychological Counsellor
(teacher)



SUCHANDRA GUPTA
Project Co-ordinator, CINI
Deals with Mental Health

DATE: 17TH MARCH 2023
TIME : 2PM

[CLICK HERE TO REGISTER HERE](#)

The organizing committee was formed as follows

ORGANIZING COMMITTEE		
Organizing Chairperson	Dr. Nibedita Mukharjee	HOD, BSH
Convener	Labani Nandi	Assistant Professor, AHOD
Member	Ishika Ghosh	Assistant Professor
Member	Payel Chakraborty	Faculty
Member	Rajalakshmi Chandrasekhar	Assistant Professor
Member	Pragati Ghosh	Assistant Professor
Member	Sreyashi Sengupta	Assistant Professor

Principal
Regent Education & Research Foundation
Bara Kanthalia, P.O. - Sewli Telinipara
Barrackpore, Kolkata- 700121

Campus : Regent Education & Research Foundation Group of Institutions

E-mail : rerfolkata@gmail.com, Website : www.rerf.in

Campus Address:

Bara Kanthalia, Barrackpore
P.O: Sewli Telinipara, P.S.: Titagarh
Kolkata - 700 121
Tel.: 033-3008-5442/432/431, Fax: 033-3008-5442

Regd. Office Address:

11/3, Biresh Guha Street
7th Floor, Kolkata - 700 017
Tel.: 033-3221-3013



REGENT EDUCATION & RESEARCH FOUNDATION GROUP OF INSTITUTIONS

PICTURES:



Principal
Regent Education & Research Foundation
Bara Kanthalia, P.O. - Sewli Telinipara
Barrackpore, Kolkata - 700121

Campus : Regent Education & Research Foundation Group of Institutions

E-mail : rerfkolkata@gmail.com, Website : www.rerf.in

Campus Address:

Bara Kanthalia, Barrackpore
P.O: Sewli Telinipara, P.S.: Titagarh
Kolkata - 700 121
Tel.: 033-3008-5442/432/431, Fax: 033-3008-5442

Regd. Office Address:

11/3, Biresw Guha Street
7th Floor, Kolkata - 700 017
Tel.: 033-3221-3013



REGENT EDUCATION & RESEARCH FOUNDATION GROUP OF INSTITUTIONS



CERTIFICATE:



Principal
Regent Education & Research Foundation
Bara Kanthalia, P.O. - Sewli Telinipara
Barrackpore, Kolkata - 700121

Campus : Regent Education & Research Foundation Group of Institutions

E-mail : rerfkolkata@gmail.com, Website : www.rerf.in

Campus Address:

Bara Kanthalia, Barrackpore
P.O: Sewli Telinipara, P.S.: Titagarh
Kolkata - 700 121
Tel.: 033-3008-5442/432/431, Fax: 033-3008-5442

Regd. Office Address:

11/3, Biresw Guha Street
7th Floor, Kolkata - 700 017
Tel.: 033-3221-3013